

MULTI V™ 5

Total Air Solution Provider



LG ELECTRONICS VIETNAM

- Hanoi** 35F, Keangnam Landmark 72, Pham Hung str., Nam Tu Liem Dist. – Tel: 024 3934 5151
- Hochiminh** 5F, Bao Viet Building, 233 Dong Khoi str., Dist 1 – Tel: 028 3925 6886
- Danang** 9F, Indochina Building, 74 Bach Dang str. – Tel: 0236 3691 307
- Nhatrang** 7F, Nha Trang Building, 42 Le Thanh Phuong str. – Tel: 0258 3813 468
- Halong** Shophouse, Lot D2 -06, Ha Long Marine Plaza, Bai Chay - Tel: 02033900369
- Hotline** 18001503

www.lg.com/vn/business | www.lghvac.vn | www.partner.lge.com

 ĐIỀU HÒA TRUNG TÂM LG  LG Vietnam

*For continual product development, LG reserves the right to change specifications or designs without notice

<http://partner.lge.com> | <http://www.lg.com/vn/business>



10 ADVANTAGES OF MULTI V

1 ULTIMATE EFFICIENCY

Ultimate Energy Saving with Dual Sensing Control.

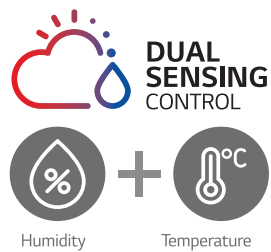

2 INNOVATIVE TECHNOLOGIES

- MULTI V 5**
- Ultimate Inverter Compressor
 - Biomimetics Technology Fan



3 SUPERIOR DURABILITY

LG's exclusive "Black Fin" heat exchanger is designed to perform even in corrosive Environments.



Certified protection



- ※ Verification of corrosion resistance performance
- Declared by TUV Rheinland
 - Test Method B of ISO21207
 - Test condition : Salt contaminated condition + severe industrial/traffic environment

4 DESIGN FLEXIBILITY

Flexible Installation with Large Capacity Outdoor Unit.

MULTI V 5 enables easy type change-over to suit the purpose of any building.

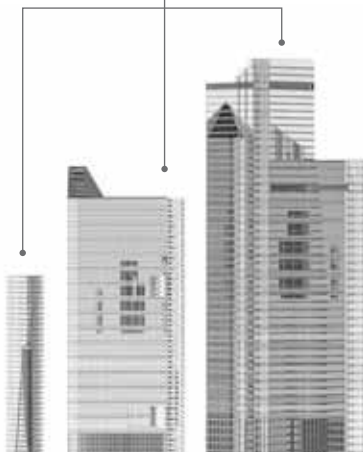

5 SMART CONTROLS

MULTI V responds to diverse building environments with LG ThinQ-based AI control and individual/central integrated control solutions.



7 DIVERSE PRODUCT LINE UP

LG offers a specialized product lineup suited for various business environments, perfectly responding to the unique conditions no matter the use case.

8 DIVERSE INTEGRATED SOLUTION

Integrated solution optimized for various business environments, including hot water, AHU, BMS, and EMS.

6 BUSINESS SUPPORT

- Engineering Tools & Support
- LG Air Conditioning Academy
- Asia Regional HQ

9 MADE IN KOREA

LG MULTI V line-up emphasizing high quality and durability with Korea made products.



10 BRAND RELIABILITY

Global production sites facilitate world-class customer service.



MULTI V BRAND HISTORY

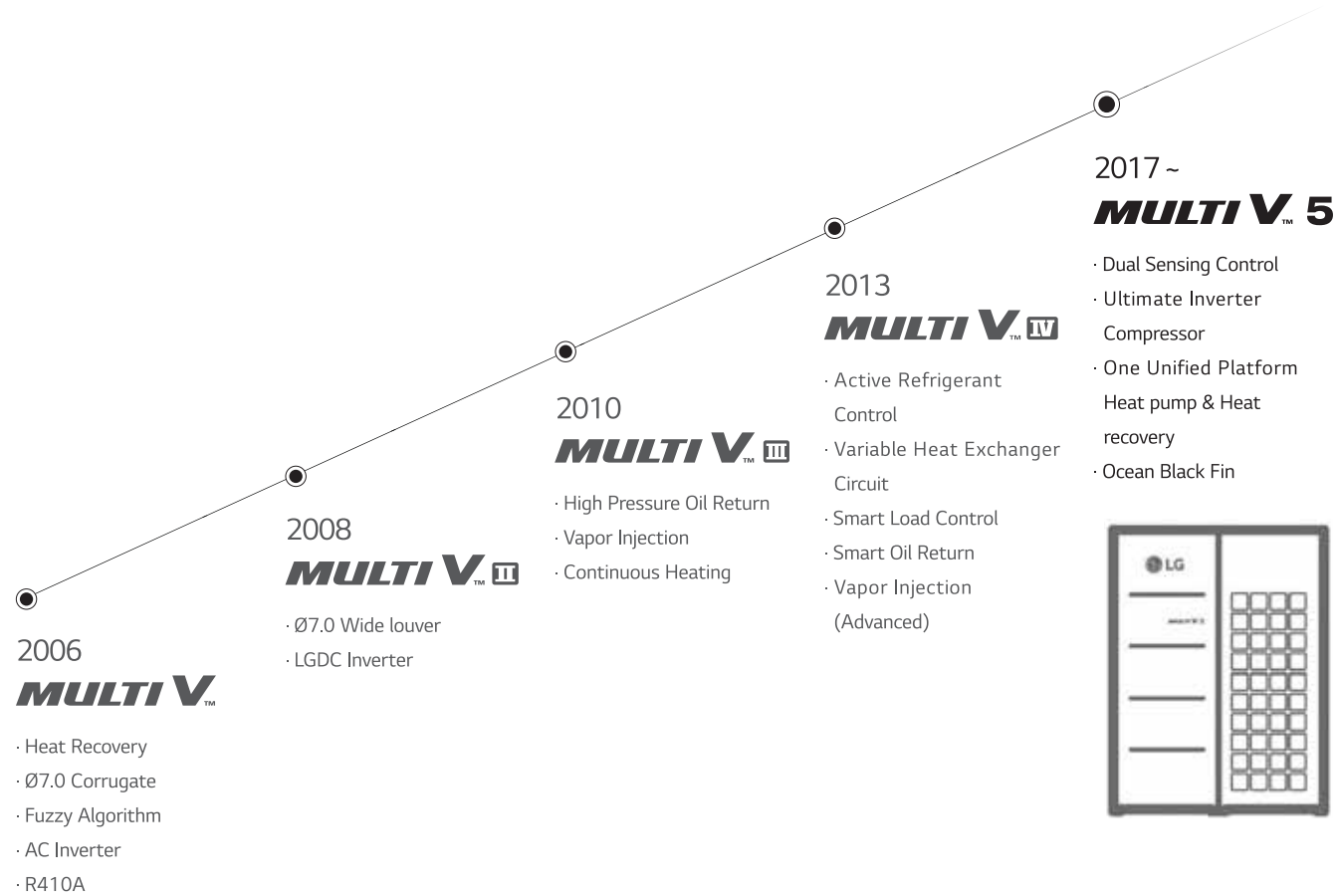

Since the time when LG launched Korea's first residential air conditioner in 1968, the company has worked to continuously enhance its technological innovation and reliability. As a result of sustained improvement, LG VRF launched the first generation of MULTI V in 2006 and achieved significant development. With the best-in-class compressor technology and innovation applied to every part and control solution, MULTI V has evolved to be on of the world's most efficient and reliable VRF solutions.

The first and second generations of MULTI V boasted inverter technology and non-ozone depleting technology, while MULTI V III was produced with cutting edge tech like oil return with HiPOR™ and double compression features with mid-pressure refrigerant allowed by Vapor Injection. The innovative technologies of MULTI V's fourth generation brought about product leadership in efficiency. Its Smart Load Control adjusts with the outdoor temperature, while optimizing refrigeration management and heat exchange for both cooling and heating.

MULTI V's wide range of VRF solutions satisfies various building types and sizes. MULTI V S's size discharge was designed for small to mid-sized buildings while MULTI V Water is a water-cooled VRF solution with variable water flow control technology.

In 2017, the ultimate VRF solution was introduced with MULTI V 5. This generation has fully improved its technological potential with the powerful and reliable yet economical Ultimate Inverter Compressor, effective corrosion resistance with the Ocean Black Fin coating and enlarged fans. Dual Sensing Control offers the most pleasant indoor environment while minimizing unnecessary energy loss by sensing both temperature and humidity to efficiently manage cooling, heating and part load.

MULTI V 5 has been designed for the ultimate efficiency, performance, flexibility, comfort and control, ensuring the most pleasant indoor experience.

INFRASTRUCTURE IN ASIA



LG Vietnam Air Conditioning Academy

LG academy is supposed of LG showroom which LG home appliance and air conditioning projects are displayed and LG practice room which we instruct LG HVAC product knowledge and software as well by using directly with LG displayed materials.



LG Whisen Park

LG Air conditioning Academy is a key infrastructure for the company's Total Climate Control business. HVAC business differs from ordinary air conditioning businesses in that as a B2B sector, the three elements of sales, installation and service must come together to create good results.



ENGINEERING TOOLS & SUPPORT

From planning to service & maintenance and then to de-construction, an architectural project goes through many stages from the beginning to the end of its lifecycle. Along those stages, various engineering tools are applied to solve the diverse issues happening in each stage, with the most optimal solution possible. Given the usage of such tools, buildings are effectively designed, built, supervised, and maintained throughout their lifecycle.

Dedicated to provide the best HVAC engineering support, LG Electronics Air Solution Business Unit offers several engineering tools and solutions focused on HVAC, during the overall lifecycle of a building, related to the three categories. Among them, the LATS* Program series has been developed to offer the best tool for LG HVAC systems, providing our customers with a solution that allows for faster, easier and more accurate model selection, draft energy estimations and more.

* LATS : LG Air-conditioner Technical Solution



I

**Energy Estimation
& Energy Modeling**



II

**Model Selection
& Design**



III

**Installation
Environment
Simulation**

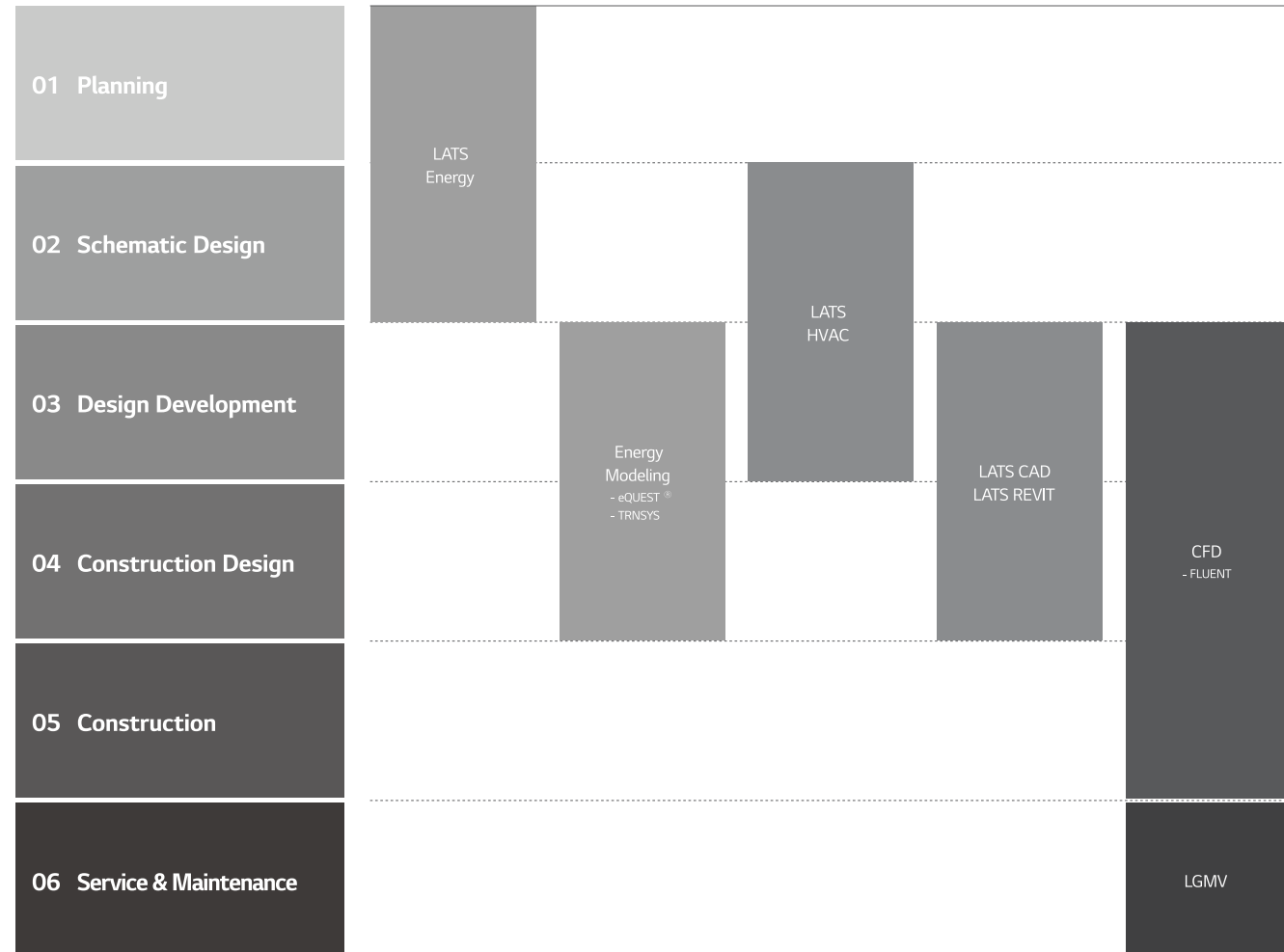

01 Draft Energy Estimation

LATS Energy

LATS Energy is a program developed by LG to estimate energy consumption and analyze the life cycle cost of LG commercial air conditioning systems during a project's early stages.



02 Building Energy Modeling

eQuest, EnergyPro, Trace700 and More

These are certified commercial programs which assess the HVAC system efficiency and building's annual energy savings for building standards or certifications, like LEED. LG HQ supports these programs for the project stages of Design Development and Construction Design where in the overall designing is finished.

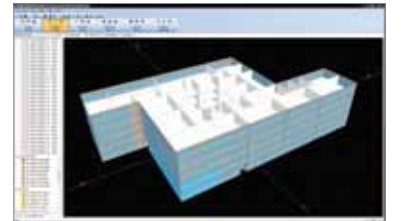

03 Model Selection

LATS HVAC

LATS HVAC is a model selection program that accurately and quickly selects the most suitable LG commercial air conditioning systems for each design. In addition to model selection, faster estimation on refrigerant piping diameter and additional refrigerant is possible, along with auto printing of reports.



04 Design

LATS CAD

LATS CAD enables faster and more accurate 2D design of LG commercial air conditioning systems. It also enables modules for quotation and installation review that minimize inherent problems during installation and commissioning.
ⓧ AutoCAD program is required.



LATS REVIT

LATS REVIT allows BIM users to have an attractive 3D design of LG commercial air conditioning systems with embedded calculations for refrigerant and efficiency features.
ⓧ AutoCAD Revit program is required.



05 Environment Simulation

CFD Analysis

CFD Analysis is applied in areas of estimating indoor airflow and temperature distribution while operating VRF products, outdoor airflow distribution, and noise level. By running a simulation before construction, engineers estimate possible issues and find optimal solutions for malfunctions that could occur after construction.

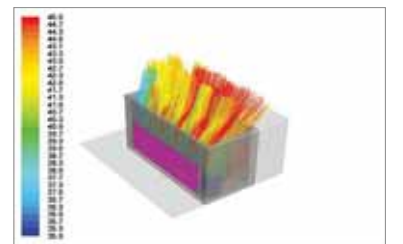

06 Service & Maintenance

LGMV

LGMV offers real-time MULTI V cycle monitoring. During start-up, LGMV can check for normal operation as well as troubleshoot any errors. Also it helps to find causes of errors and solve the problem faster.



BENEFITS OF LG MULTI V

Benefits for Building Owners



Efficient Management & Cost Reduction

- Fault Detection Diagnosis enables easy maintenance
- Requires no extra manpower for regular maintenance
- With diverse control systems, maintenance cost is minimized



Reliability at Every Stage

- Ultimate Inverter Compressor developed and manufactured in Korea
- Corrosion resistant Ocean Black Fin for harsh conditions operation
- Smart Oil management (Auto Oil Balancing and Active Oil return) decreases compressor damage



Customized Comfort and Solution

- Compatible option between Heat pump and Heat recovery system is possible



Benefits for Consultants



Versatile Solutions

- Air-cooled, Water-cooled, Heating, and Air Handling Unit interlocking solutions



Professional Design Support

- LATS (LG Air-conditioner Technical Solution) for draft energy estimation, model selection, HVAC design and 3D designing
- CFD Analysis to ensure suitable solutions and prevent malfunctions
- Energy simulation offered to find the optimal solution



Optimized Convenience with HVAC Design

- Flexible and longer piping length facilitates HVAC designing process
- Meets any type of customer requirements of diverse environment, design conditions, and building applications



Benefits for Developers & Construction Companies



Green Solutions

- Optimized for LEED/BREEAM certification
- Renewable energy solution provided through geothermal application



Maximizing Space Utilization

- Large capacity in compact size enhances space utilization



Smart Building Solutions

- Seamless integration with current Building Management Systems
- Wi-Fi control available for anytime, anywhere access (via the 'LG ThinQ' mobile app)
- Energy management and control according to usage and planning is possible with LG's centralized control solution



Benefits for End-users



Cost Saving Operation

- High efficiency guaranteed throughout product line-up
- Up to 31% cost savings with MULTI V's Smart Load Control*



Comfort Cooling & Heating

- Smart Load Control maximizes indoor comfort level
- Dual Sensing Control offers pleasant and comfortable cooling and heating environment
- Duration time of Continuous Heating is 11% longer than previous model**



Convenient Functions

- Low-noise operation provides a pleasant environment

* Dual Smart Load Control ESEER based, below 50% humidity, model ARUM260LTE5
 ** LG internal test result



APPLICATION SOLUTIONS

Office

Supporting efficiency with flexibility

High Rise Office Building



Small to Medium sized Office Building



The MULTI V series revitalizes the workspace by providing fresh air at all times. LG's intelligent control solutions add comfort to any space.

Residential

Creating a comfortable home

Apartments



MULTI V 5 HP with various IDU enables optimal solution, providing comfort to every space through individual zone control and hot water solution.

Commercial

Maximizing business, minimizing cost

Shopping Mall



Retail



Quick Service Restaurant (QSR)



The highly efficient, energy saving MULTI V 5 and MULTI V reduces operation costs, and provides comfort that suits any purpose and any space, helping to invest the extra space and expense to your business.

Hospitality

Meeting diverse needs



The diverse applications that can be applied to MULTI V 5 helps bring just the right solution to a sophisticated hotel business.

* PDI : Power Distribution Indicator ** CST : Cassette

DIVERSE INTEGRATED SOLUTION

Air Handling Unit (AHU) Solution

AHU is a suitable solution for cooling and heating in large space. With an LG AHU Comm. Kit (for both return air / supply air control) connected to the DX coil of the AHU, LG VRF system can be applied to deliver conditioned air.

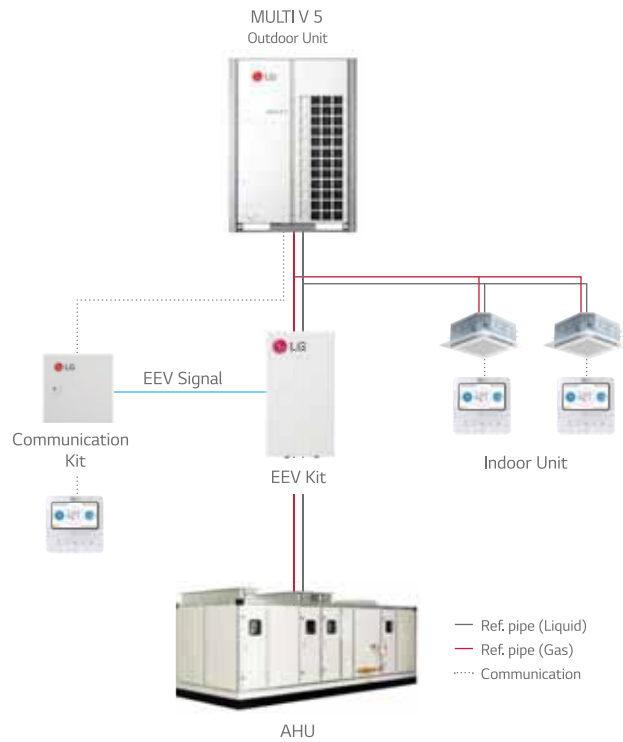

Refrigerant Leak Detection Solution

Real-time refrigerant leak detection ensures a safe environment. When refrigerant concentration exceeds 6,000ppm for 5 seconds, the indoor unit will stop operation and alert users with a buzzer or light switch (Dry contact option).

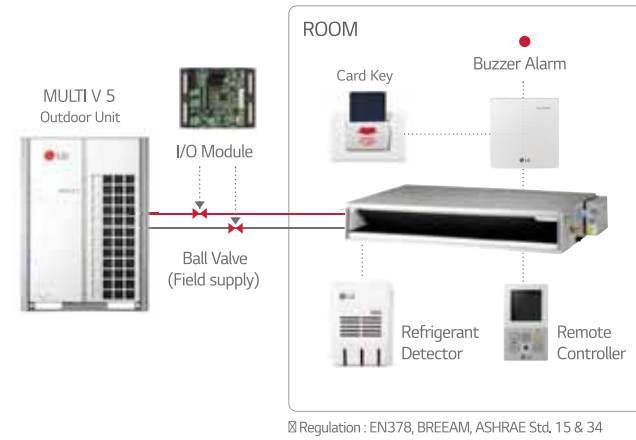

Power Consumption Distribution Solution

In case of shared power consumption in a building, a solution to distribute the power consumption amount per tenant might be necessary. Electricity charges can be billed to each tenant by using output from the LG Power Distributor Indicator (PDI). An administrator is able to check the power usage for each space and date as needed. If the PDI is used in conjunction with an LG central controller, the results can be exported to Excel.

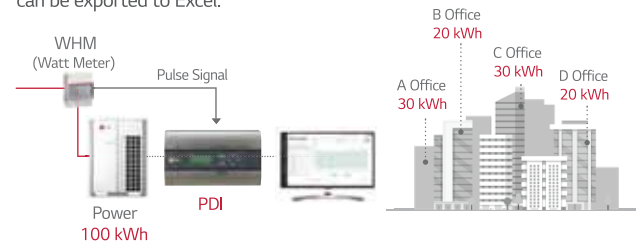

Total Control of Any Device

In order to manage multiple spaces and multiple buildings, the administrators should be able to control systems from wherever they are. The LG central controller can be controlled from any web browser that supports HTML5. Now through the implementation of HTML5, the interface will look great and perform well on any device.



DIVERSE INTEGRATED SOLUTION

Energy Management Solution

Since HVAC systems use a significant portion of any building's total amount of energy, the energy saving functions of a controller can make a big difference. The energy navigation function enables you to set target values for energy consumption over a certain period of time. In addition, to achieve that value, the administrator can set the energy saving logic in 7 steps and predict the expected usage relative to the target value. Active self-management enables energy savings throughout the building.



Integration Solution with BMS

There are many BMS protocols used for the control of buildings' various systems such as HVAC, lighting, power and security. LG has a wide range of gateway products for different protocols such as BACnet, Modbus, and LonWorks. In addition, LG gateways include Stand-alone central control capability to act as a back-up controller of the BMS if needed.

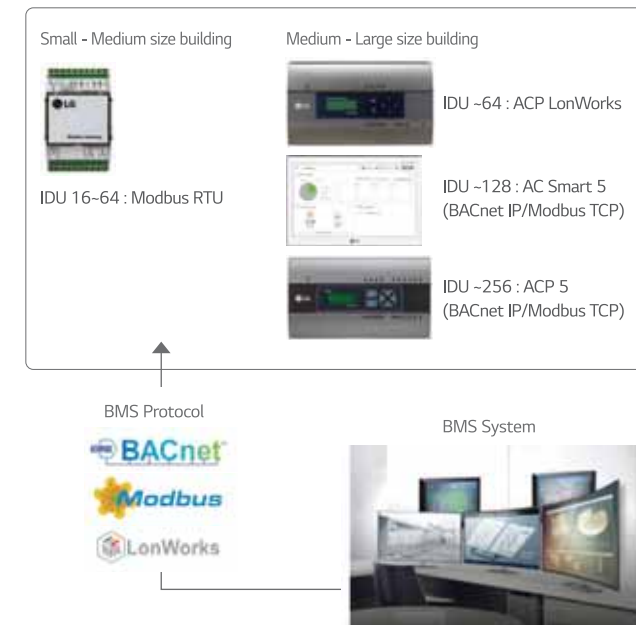

Interlocking Solution by Using ACU Module

It is costly to introduce a BMS system to control multiple devices or systems in a small building. With the ACU module, various IO contact points (DI, DO, UI, AO) can be interlocked and integrated, while control is possible from the LG central controller. This enables an efficient management of lighting, pumps and other devices in the building in conjunction with the HVAC system.



Interlocking Solution Using Dry Contact





3rd party thermostats can be used to control LG air conditioners in a room by using a multi point dry contact. The dry contact enables basic control of air conditioners as well as making it possible to report the status and any errors impacting the indoor unit.

The Standard III remote control has a DO port. With this DO port, it is possible to interlock the indoor unit with 3rd party devices such as lighting, a fan, or a radiator, based on things like operation mode or current temperature.

The indoor unit can be interlocked with various types of input such as card key-tag, door sensor, human detection sensor etc. so that the air conditioner is automatically operated. In addition, the dry contact option settings enable operation of air conditioner to maintain proper temperature when the occupant is absent. This solution makes sure that the room does not overheat or become too cold when unoccupied so that energy cost can be saved.



OUTDOOR UNITS LINE-UP

Features	Appearance	8	10	12	14	16	18	20	22	24	26	28	30	32
<p>MULTI V™ 5</p> <ul style="list-style-type: none"> • Dual Sensing Control • Large capacity ODU (Up to 32HP) • Continuous Heating • Black Fin heat exchanger • Heat pump function • For large space, high rise building and individual control building 		●	●	●										
					●	●	●	●	●	●	●			
										●	●	●	●	●
														
														

Unit : HP / ● 380V, 3Ø

34	36	38	40	42	44	46	48	50	52	54	56	58	60	62	64	66	68	70	72	74	76	78	80	82	84	86	88	90	92	94	96	...	104	
●	●	●	●	●	●	●	●																											
								●	●	●	●	●	●	●	●	●	●	●	●															
																				●	●	●	●	●	●	●	●	●	●	●	●	●	●	

INNOVATIVE TECHNOLOGIES

Dual Sensing Smart Load Control (SLC)

Enhanced energy saving & increased indoor comfort

Cooling loads vary according to both temperature and humidity. With Dual Sensing SLC, work exerted to meet the load depends on both temperature and humidity. As a result, less capacity will be required in lower humidity conditions.

It influences the VRF system main processor's decision on where to set the system's target high or low system pressure values.

Smart Load Control responds to :

- 1) Outdoor ambient dry bulb temperature
- 2) Outdoor ambient relative humidity (when enabled)

Cooling Indoor Units - adjusts target low pressure

Raises the target low pressure value as cooling load falls and/or ambient temperature falls. Lowers the target low pressure value as cooling load rises and/or ambient temperature rises.

Heating Indoor Units - adjusts target high pressure

Lowers the target high pressure as heating load falls and/or ambient temperature rises. Raises the target high pressure as heating load rises and/or ambient temperature falls.

What are the benefits?

Enhanced energy savings

- Cooling Mode

By raising the target low pressure during off-peak cooling operation, the compressor lift is reduced. This slows compressor's speed which leads to a decrease in compressor's power consumption.

- Heating Mode

By lowering the target high pressure during off-peak heating operation, the compressor lift is reduced. This slows compressor's speed which leads to a decrease in compressor's power consumption.

Increased indoor comfort

Smart Load Control uses one (or two) sensors to measure changing outdoor weather conditions and prepares the VRF system for operation under the revised weather conditions before changing conditions impact indoor comfort.

Cooling load according to temperature change

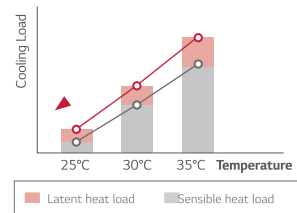

Cooling load according to humidity change

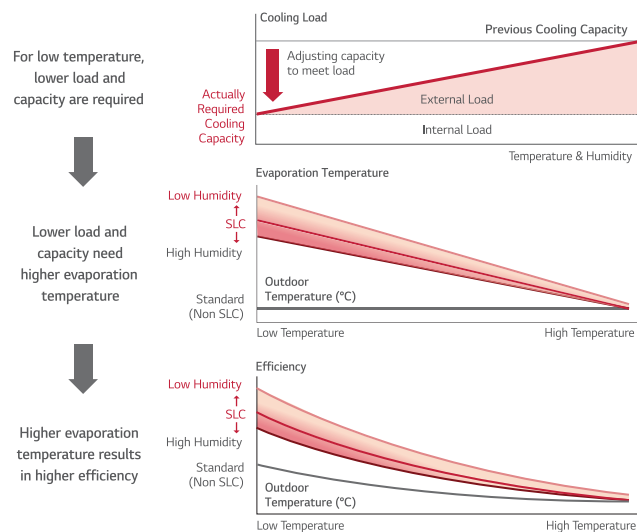
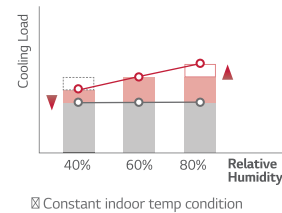

Energy Savings with Dual Sensing Control (Temperature & Humidity)

Case study

Weather characteristics of Warsaw, Poland

The portion of cooling operation hours at low humidity condition (Below 50% RH) is big. The cooling load of this condition is less than the load at standard (50 - 70% RH) or high (over 70% RH) humidity condition even in the same outdoor air temperature. MULTI V 5 raises the evaporating Temp up at low load (Low humidity) condition to enable energy saving and prevent over-cooling which can happen when the system is controlled only by using outdoor air Temp.

Warsaw weather in Summer

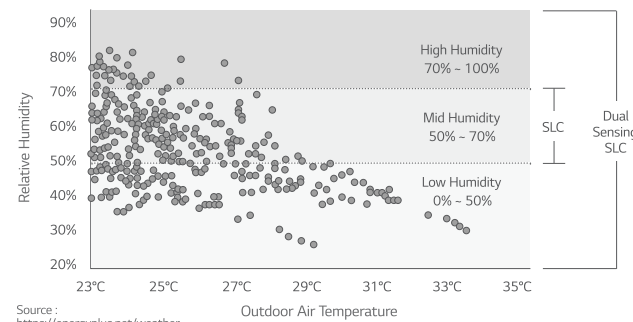

Source: <https://energyplus.net/weather>

Time Portion of Relative Humidity in Summer (Warsaw, Poland)

RH (%)	Portion
70% - 100%	8%
50% - 70%	45%
0% - 50%	47%

Energy Consumption in Cooling Season

When we compared the energy consumption between SLC (Outdoor air Temp sensing only) and Dual sensing SLC (Outdoor air Temp and humidity sensing), Dual sensing SLC control can save 6% more energy compared to SLC. So dual sensing control is more efficient than SLC.

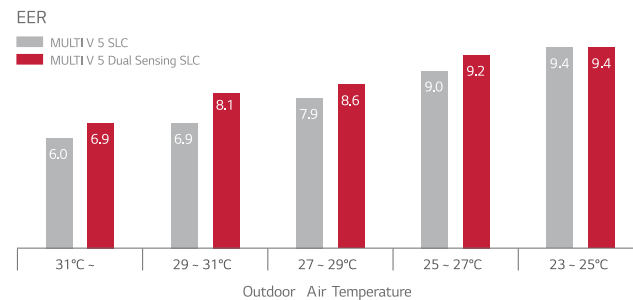

※ This energy simulation was performed in LG internally based on 16HP model.

Power Consumption in Cooling Season

Yearly Power Input (kWh) - ODU

OAT	MV4 (Fixed)	MV5 SLC	MV5 Dual.SLC
31 -	17	15	13
29 - 31	91	73	62
27 - 29	183	136	124
25 - 27	243	170	165
23 - 25	155	110	109
Total	690 (137%)	503 (100%)	474 (94%)

6% more energy saving compared to SLC

INNOVATIVE TECHNOLOGIES

Comfort Cooling

Increased indoor comfort & enhanced operating efficiency

First reference use Indoor Unit (IDU) is operating in a season when its load is less than the design load, the comfort cooling algorithm controls the indoor unit's coil superheat, thus raising the discharged air temperature as the space temperature is approaching set point. MULTI V 5's comfort control algorithm monitors the outdoor air temperature and humidity conditions. When changing weather conditions are deteriorating and there is a high potential the indoor unit's load will remain stable or may increase, comfort cooling delays or abandons raising the target superheat as the room temperature approaches set-point. When changing weather conditions are favorable to raising target superheat, target superheat is moderated.

What are the benefits?

Increased indoor comfort

If comfort cooling is turned off, and the temperature of the leaving air is not raised, when the fan speed is reduced to low speed, there is a potential that occupants located directly under a cassette IDU or supply air registers could feel cold air falling on them resulting in a lower overall comfort experience. With comfort cooling turned on, the discharged air temperature is controlled. When the IDU controller reduces the fan speed, the potential for cold air falling on occupants located under the cassette IDU or supply air registers is reduced.

Enhanced operating efficiency

Raising superheat reduces refrigerant volume flowing through the coil. As flow decreases, demand on the compressor decreases and the compressor speed will be reduced, thus saving energy.

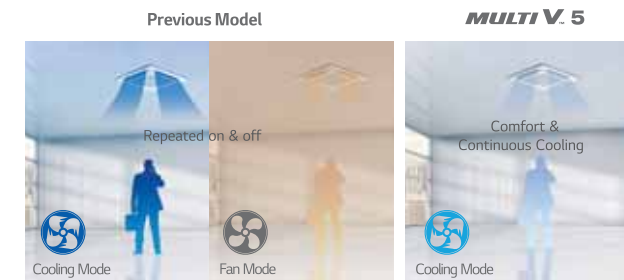

※ Indoor unit set up available with Standard III Remote Controller.

Preventing cold draft & repeated turn On / Off

Improved Indoor Comfort

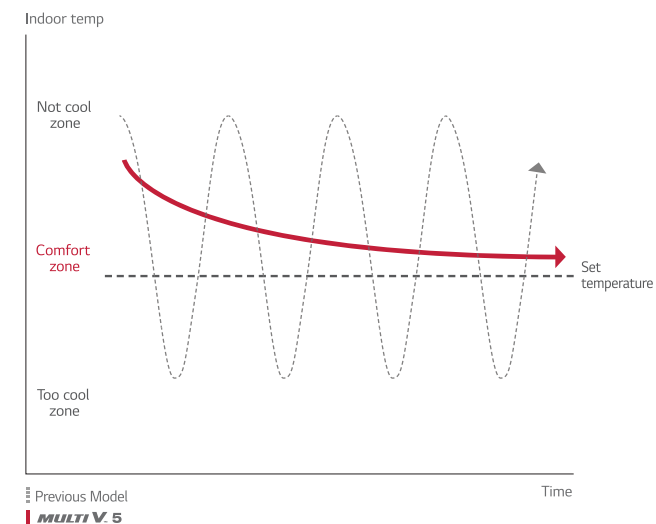

Intelligent Defrost

Increased heating run-hours

MULTI V has provided an intelligent defrost algorithm and settings based on current outdoor ambient temperature. With the addition of the outdoor air humidity sensor, MULTI V 5 Intelligent Defrost just got smarter.

MULTI V 5 computes the current ambient air dew point temperature - the temperature at which frost will form on the outdoor unit coil in during winter operation. MULTI V 5 makes continuous adjustments to the refrigeration cycle's operating parameters to keep the outdoor coil surface temperature above actual dew point which can be calculated by using dry bulb Temp and relative humidity. When the refrigeration cycle's operating parameters can be adjusted no further without sacrificing heating comfort, further adjustment is stopped and frost is allowed to build on the coil, therefore activating defrost.

What are the benefits?

The Intelligent Defrost algorithm increases the VRF system's heating run-hours and reduces the number of defrost cycles required to maintain optimum heating performance irrelevant of the mode and method of defrost selected.

Conventional Defrost

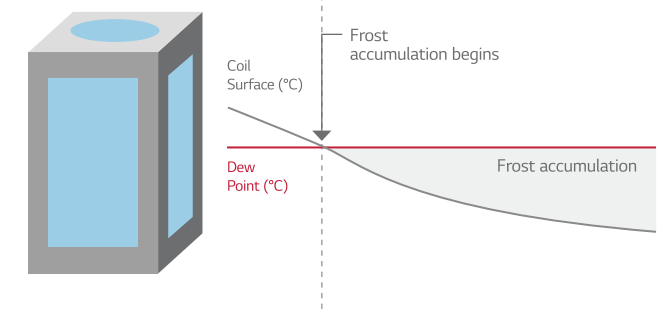

LG Intelligent Defrost / Smart Heating

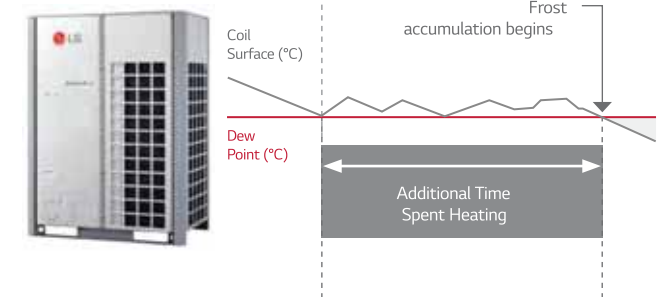

※ Increased heating operation time per day : Up to 17%

- LG Internal Test result,
- Test condition (MULTI V 5 vs MULTI V IV, 22HP)
- Outdoor : 2/1°C, Indoor : 20/15°C
- Humidity : 83%, Dew Point : -0.5°C

INNOVATIVE TECHNOLOGIES

Variable Path Heat Exchanger

Optimized system efficiency & continuous heating

MULTI V 5 outdoor units (ODU) are manufactured with horizontally split ODU coil consisting of two independent circuit sections. Each half of the coil is independently controlled.

This split coil feature makes it possible for MULTI V 5 to provide continuous heating during defrost. The split coil and valve arrangement also makes it possible for the MULTI V 5 to change the flow path of refrigerant through one of the two coils only, or through both coils in either a series or parallel arrangement. Based on system pressures, ambient temperature conditions, and mode of operation, the system controller may modify the selected path at any time.

What are the benefits?

Optimizes system efficiency regardless of operating modes as ambient weather conditions change.

Customizes the used area of the outdoor unit's heat exchange surface.

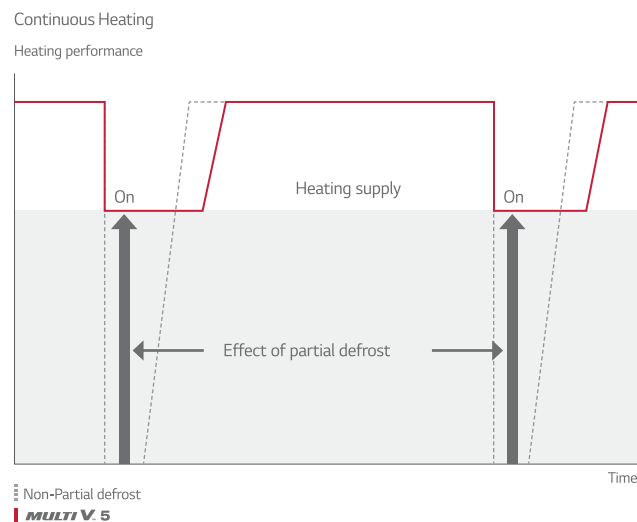
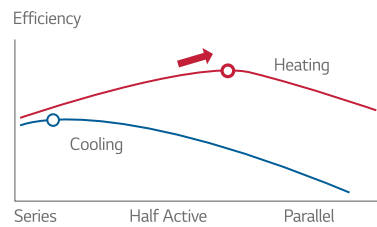

Active Refrigerant Control

Stable operation & sustaining most efficient operation

The accumulator in the outdoor unit has a storage tank mounted inside known as the receiver tank. The receiver tank is equipped with inlet and outlet valves that are electronically opened and closed. Refrigerant is being passed between the accumulator and the receiver tank on a continuous basis. MULTI V 5 active refrigerant control algorithm goal is to minimize the amount of refrigerant in circulation. The lower the volume in circulation the lower the cost to move it around the system and the higher the stability of the refrigeration cycle. It accomplishes this by constantly monitoring the system operating pressures and temperatures and a variety of other vital control metrics of the refrigeration cycle. When the cycle is out of balance, an adjustment in the amount of circulating refrigerant occurs.

What are the benefits?

Widens the ambient temperature range at which stable operation occurs. Sustains most efficient system operation regardless of outdoor weather conditions, operating mode, or building load.

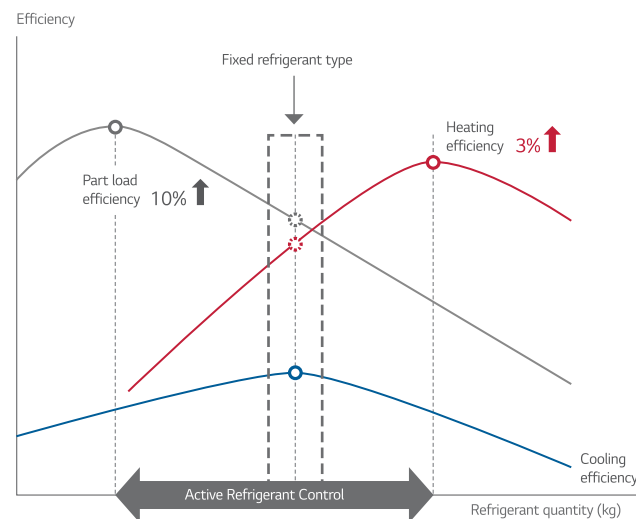
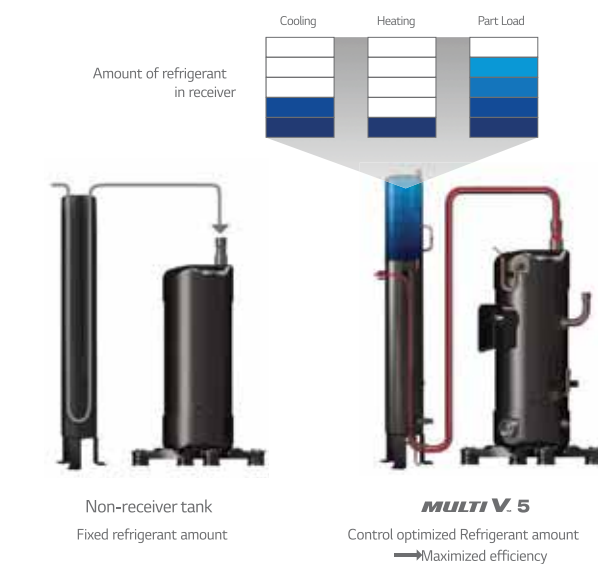

INNOVATIVE TECHNOLOGIES

HiPOR™

Advanced compressor reliability & efficiency

HiPOR™ is an LG trademark that stands for High Pressure Oil Return. It consists of an oil separator, oil drain line between the separator and the compressor. HiPOR™ technology enables oil to return directly into the compressor, instead of returning through the refrigerant suction pipe. This prevents energy waste when oil flows between the separator and the compressor. Because the operating pressure in the chamber containing the oil sump of the compressor and the pressure in the oil separator are nearly equal, there is no loss in compressor efficiency.

What are the benefits?

Maximizes reliability and efficiency of the compressor.

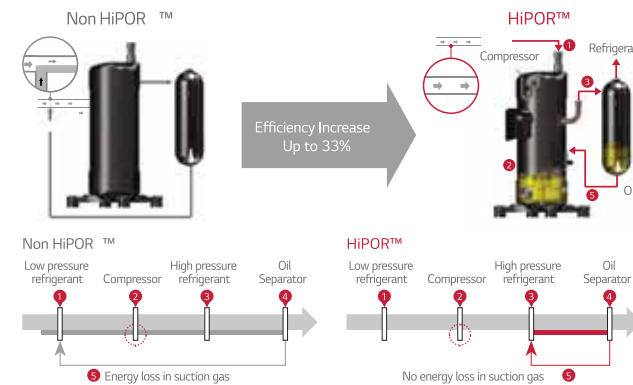

- LG Internal Test result,
- Test condition - 15Hz Rating Condition : TC = 37.9°C, Te : 7.2°C

Smart Oil Management

Energy saving, enhanced heating & increased compressor reliability

MULTI V 5 performs oil return when needed under normal operating conditions. An oil level sensor is provided in every LG VRF compressor. If the sensor indicates the compressor oil level is low, the main system processor is notified that an oil return cycle is necessary. Oil balancing cycle occurs every hour and does not hinder system performance. It balances the oil level deposit between both compressors in multi-compressor frames. Older VRF technology protects compressors from oil loss based on timed oil return logic because there was no way to know if the oil level in any one compressor was low. LG's unique oil level measuring sensor actively monitors the oil level in each compressor.

What are the benefits?

- Energy savings : fewer oil return cycles eliminate unnecessary energy consumption.
- Increases system heating run-time during winter operation.
- Increases compressor reliability.

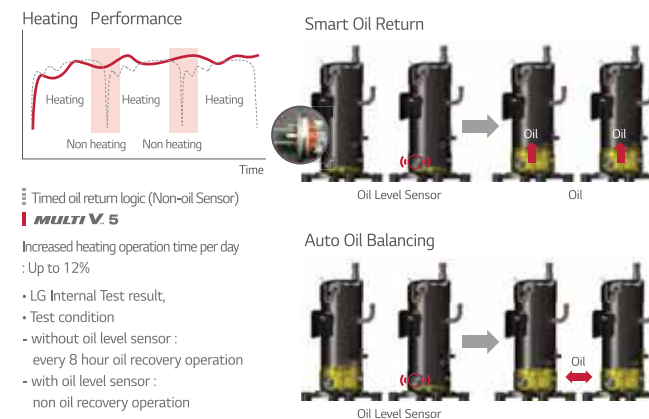

- Timed oil return logic (Non-oil Sensor)
- MULTI V 5
- Increased heating operation time per day : Up to 12%
- LG Internal Test result,
- Test condition
- without oil level sensor : every 8 hour oil recovery operation
- with oil level sensor : non oil recovery operation

Sub-cooling & Vapor Injection

Increased heating performance

MULTI V 5 is equipped with advanced sub-cooler and vapor injection control system. The sub-cooler algorithm sub-cools liquid refrigerant just enough so that it can travel to the farthest IDU in the system operating in cooling mode without changing state. During low ambient operation down to -25°C (Heating mode), the sub-cooler provides medium temperature refrigerant gas to the compressor's vapor injection system. When injected into the compression chamber, system mass flow increases which stabilizes the system's suction pressure. In all cases the vapor injection increases the compressors cycle efficiency and reduces operating cost.

What are the benefits?

Provides stable refrigeration cycle operation over a wide range of outdoor ambient operating conditions. Increases compressor efficiency when compared to systems without vapor injection technology.

Technology Mechanism

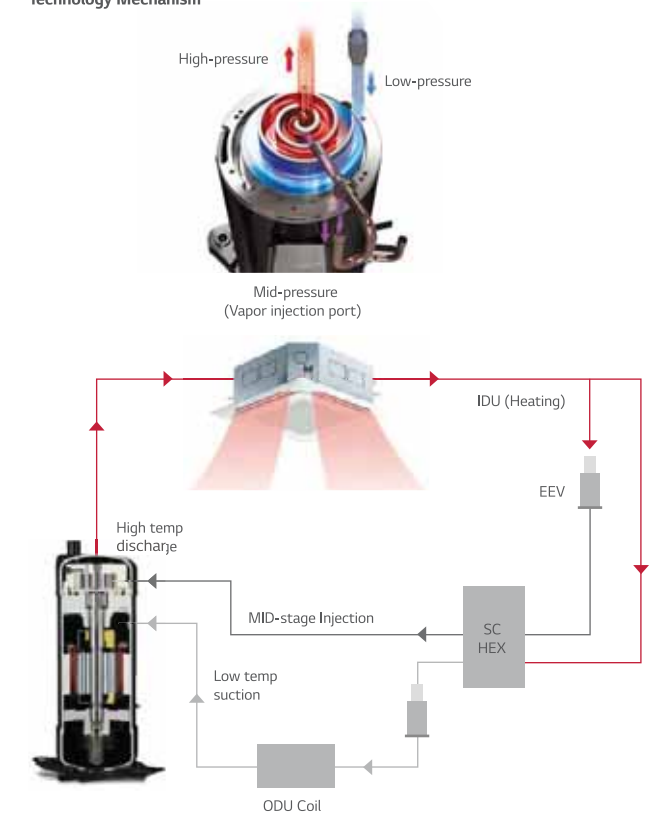

Performance Comparison

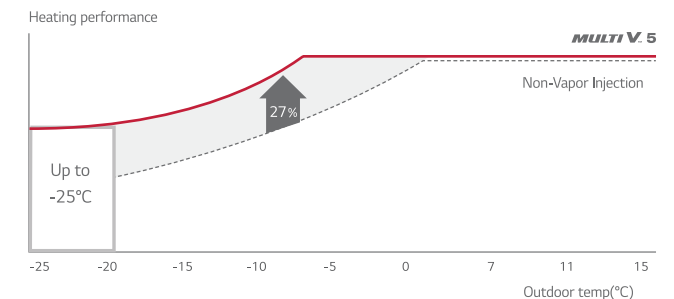

- ※ Improved heating performance by 27%.
- ※ Comparison tested on 10HP model.

INNOVATIVE TECHNOLOGIES

Corrosion Resistance Black Fin

Improved durability

The black coating with enhanced epoxy resin is applied on the heat exchanger for strong protection from various corrosive external conditions such as salt contamination and air pollution. Moreover, the hydrophilic film keeps water from accumulating on the heat exchanger's fin, minimizing moisture buildup and eventually making it even more corrosion resistant. LG Corrosion Resistance solution passed ISO 21207 accelerated corrosion test conducted by an independent test organization and the result has been certified by prestigious global certification organization, TÜV.

What are the benefits?

This improvement in durability prolongs the product's lifespan and lowers both the operational and maintenance costs.



※ Verification of corrosion resistance performance
 - Declared by TÜV Rheinland
 - Test Method B of ISO21207
 - Test condition : Salt contaminated condition + severe industrial/traffic environment(NO₂ / SO₂)

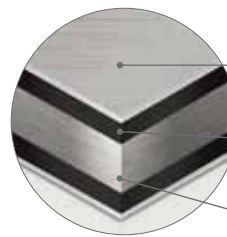

Hydrophilic film (Water flow)
 The Hydrophilic coating minimizes moisture buildup on the fin.
 Acryl + Epoxy + Melamine resin (Corrosion resistant)
 The Black coating provides strong protection from corrosion.
 Aluminum fin

SST (Salt Spray Test)

Test Process



Process repeated

Test process is conducted according to ISO 9227.
 1) Salty water concentration : NaCl aqueous solution (5%)

Test Result
 (5% Area of defects compared to initial)

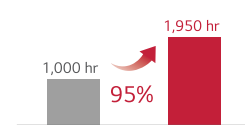

100% copper material to prevent corrosion & refrigerant leakage

CCT (Cyclic Corrosion Test)

Test Process

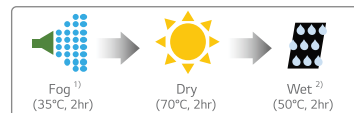

Process repeated

Test Result
 (5% Area of defects compared to initial)

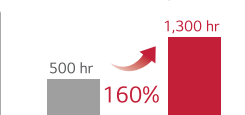

100% copper material to prevent corrosion & refrigerant leakage

※ Test process is conducted according to ISO 14933.
 1) Salty water concentration : NaCl aqueous solution (5%)
 ※ Dry condition changed : 60°C, 4hr → 70°C, 2hr
 2) Deionized water

Biomimetic Fan

Maximized performance

The fans in MULTI V 5's outdoor unit have been upgraded to feature a moire pattern similar to that of a clam shell's exterior that help with noise reduction. At the same time, unlike the fans installed in previous products that generate separation of flow due to absence of tubercles, the bumpy back design inspired by the bumps on the humpback whale's flipper is applied as the tubercles on the back side of the fans, increasing wind power by reducing flacking. In addition to the biomimetic technology-based fans, extended shroud of MULTI V 5 allows more high static pressure and helps fans to blow higher air volume for efficient operation. With wider air guide, discharged air current is stabilized and noise level is reduced.

What are the benefits?

Based on the biomimetic technology, the fans of MULTI V 5 increased air flow rate by 10% in comparison to previous model and reduced its power consumption up to 20% when compared with the fan blade design on MULTI V IV. This eventually results in maximized performance with large capacity.

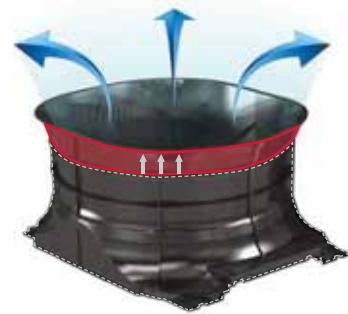

Air flow rate

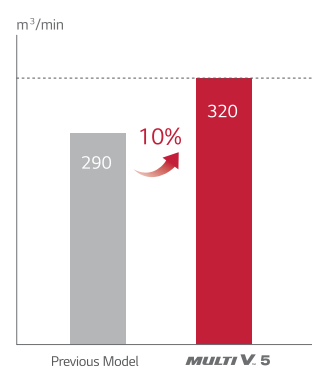

※ Comparison based on 20HP model

Power consumption

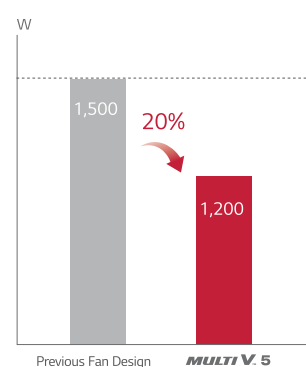

※ Comparison based on air volume of 290m³/min

DESIGN FLEXIBILITY

Flexible Installation with Large Capacity Outdoor Units

More flexible design potential & space saving

Large capacity outdoor units of MULTI V 5 minimize installation space that spares valuable floor space and significantly decreases total installed weight. This gives users more flexible design potential and better use of the saved space.

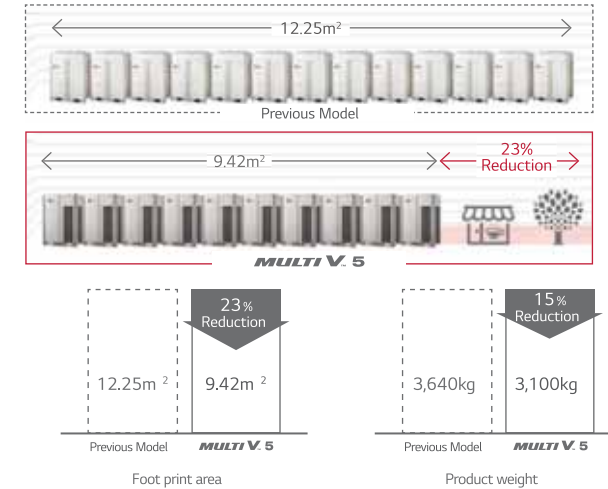

※ Comparison basis : 1 Rows of outdoor units 728kW (72.8kW x 10sets) installation case

Wider Operation Range

Able to operate at extreme conditions

With improved inverter cooling technology, sub-cooling and vapor injection, MULTI V 5 offers an extended range of heating and cooling operations. It can perform normal heating operations at temperatures as low as -25°C. Cooling operations function at temperatures as low as -15°C or as high as 48°C making it an adequate solution for specialized areas like technical rooms. Moreover, MULTI V 5's cycle technology with enhanced durability enables optimal cooling performance at high temperature that increases up to 48°C.

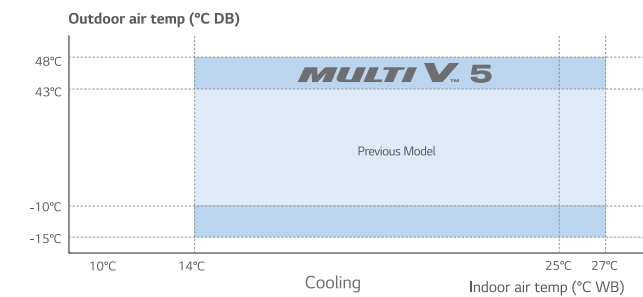
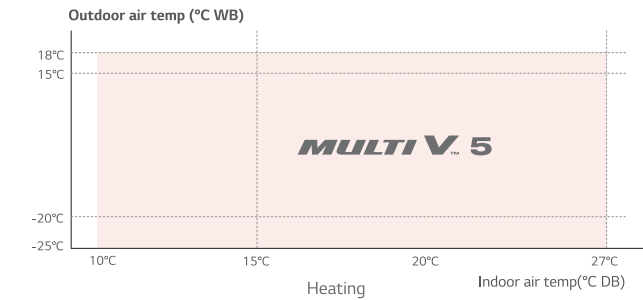

USER-FRIENDLY CONTROL

Low-Noise Operation

For noise sensitive environment

Unlike the previous model which enables Low-Noise Operation only during night after judgment time, the Low-Noise Operation of MULTI V 5 can function regardless of the time at the noise sensitive areas. When used, the speed of the outdoor unit fans is restricted during normal operation.

Previous Model

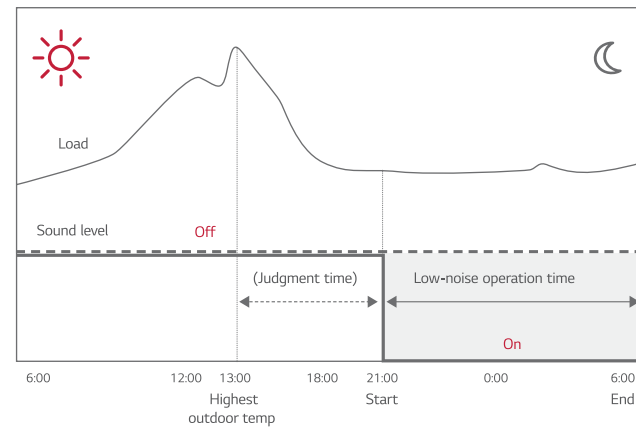

MULTI V. 5

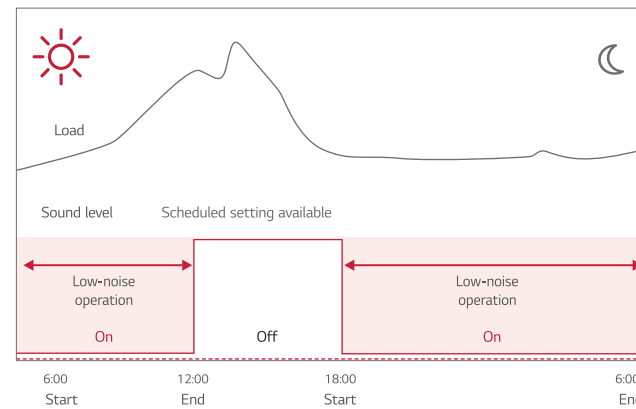

Indoor setting available



Simple Test Run via LGMV

Increased overall efficiency in installation

To make sure that the product functions properly, conducting a test run is recommended. For previous product, professional engineer who is well-aware of more than 40 different functional settings and more than 200 error codes had to check main parts in order to make sure that the test run had succeeded. With Mobile LGMV of MULTI V 5, fast and accurate auto test run can be executed and the professional installer running the test can receive test results via email, which shortens installation hours and increases overall efficiency in installation processes.

Previous



LGMV



Position of Sound Pressure Level Measuring

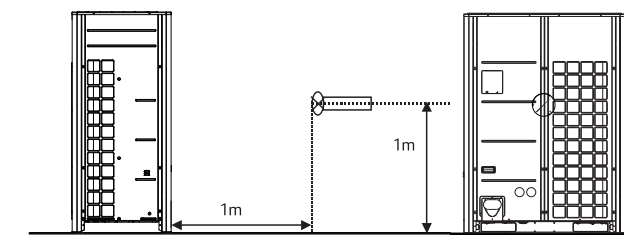

- Data is valid at free field condition.
- Data is valid at nominal operating condition.
- Sound level will vary depending on a range of factors such as the construction (Acoustic absorption coefficient) of particular room in which the equipment is installed.
- Sound level can be increased in static pressure mode or used air guide.

Outdoor Units Function

Category	Functions	MULTI V. 5
Key Refrigerant Components	Variable Path of Outdoor Unit HEX	○
	HiPOR™ (High Pressure Oil Return)	○
	Humidity Sensor	○
	Corrosion Resistance Black Fin	○
Useful Function	Oil Sensor	○
	Dual Sensing	○
	Low Noise Operation	○
	High Static Mode of Outdoor Unit Fan	○
Reliability	Partial Defrosting	○
	Auto Dust Removal of Outdoor Unit (Fan reverse rotation)	○
	Indoor Cooling Comfort Mode Based Outdoor Temperature	○
	Smart Load Control (SLC) (Changing indoor discharge air temperature according to load)	○
Central Controller	Outdoor Unit Control Refer to Humidity	○
	Defrost / Deicing	○
	High Pressure Switch	○
	Phase Protection	○
BNU (Building Network Unit)	Restart Delay (3-minutes)	○
	Self Diagnosis	○
	Soft Start	○
	Test Run Function	○
Installation	AC Ez (Simple Controller)	PQCSZ250S0
	AC Ez Touch	PACEZA000
Installation	AC Smart IV	PACS4B000
	AC Smart 5	PAC55A000
Installation	ACP (Advanced Control Platform) IV	PACP4B000
	ACP (Advanced Control Platform) 5	PACP5A000
Installation	AC Manager 5	PACM5A000
	ACP Lonworks	PLNWKB000
Installation	ACP BACnet	PQNF17C0
	Refrigerant Charging Kit	PRAC1
Installation	Variable Water Flow Valve Control Kit	-
	Cool / Heat Selector	PDI (Power Distribution Indicator) Standard
PDI (Power Distribution Indicator) Premium		PQNUD1S40
Cool / Heat Selector	Low Ambient Kit	PRVCS2
	IO Module (ODU Dry Contact)	PVD5MN000
Cycle Monitoring Device	LGMV	PRCTILO
	Mobile LGMV	PLGMVW100

※ ○ : Applied, - : Not Applied

Cooling / Heating Operation

Cooling

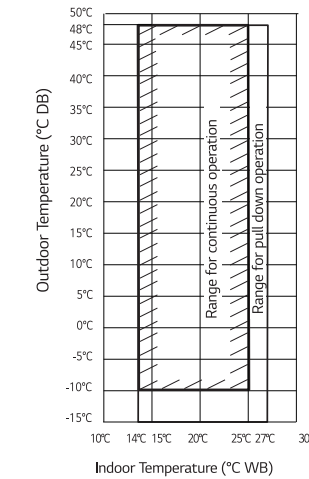

Heating

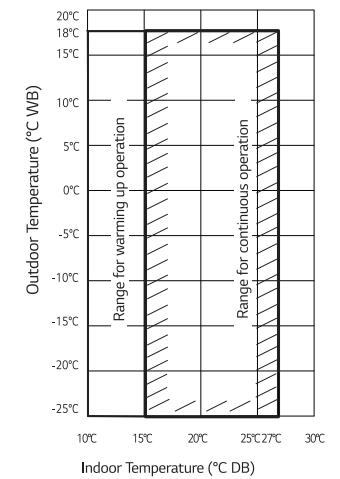

Note

1. These figures assume the following operating conditions :
Equivalent piping length : 7.5m
Level difference : 0m
2. Range of pull down operation :
If the relative humidity is too high, cooling capacity can be decreased by the sensible heat reduction.
3. Warming up operation means that the outdoor unit operates to reach the range of continuous operating, however it may not operate continuously due to safety or protection logic.

Simultaneous Cooling / Heating Operation

Cooling

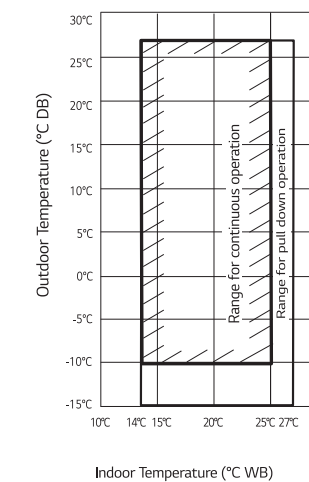

Heating

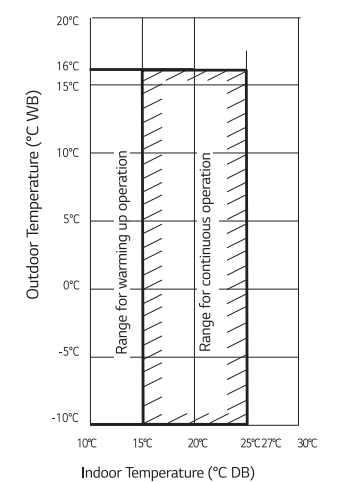

Note

1. These figures assume the following operating conditions :
Equivalent piping length : 7.5m
Level difference : 0m
2. Range of pull down operation :
If the relative humidity is too high, cooling capacity can be decreased by the sensible heat reduction.

MULTI V 5 Q&A

Q1 What are the differences between MULTI V IV and MULTI V 5?

Category	MULTI V IV H/P (ARUN***LTE4)	MULTI V 5 H/P (ARUN***LTE5)
Vapor Injection	○	○
HiPOR™	○	○
Smart Oil Control (Oil Level Sensor)	○	○
Active Refrigerant Control	○	○
Variable Heat Exchanger Circuit	○	○
Continuous Heating	○	○
Smart Load Control	○	○
Dual sensing (Humidity Sensor)	-	○
Comfort Cooling	○	○
Ocean Black Fin	-	○
Maximum Capacity (1 Unit / 4 Unit)	20 HP / 80 HP	26 HP / 96 HP
Height Difference (ODU - IDU / IDU - IDU)	110m / 40m	110m / 40m
Cooling Operating Range (OAT, °CDB)	-10 - 43	-15 - 48
Heating Operating Range (OAT, °CWB)	-25 - 18	-25 - 18
Combination ratio of IDU	1 Unit	50 - 200%
	2 Unit	50 - 160%
	3 or 4 Units	50 - 130%

※○ : Applied, - : Not Applied

Q2 Can MULTI V 5 ODU be connected with the 2 series indoor unit?

A2 Yes, MULTI V 5 ODU can be connected with the 2 series indoor unit. In this case, the ODU DIP Switch No.3 should be "OFF" which is default setting. Refer to the below table.

ODU	IDU	Compatibility	ODU DIP Switch No. 3	If dip switch setting is not correct	Ref.
	Gen. 2 (ARNU*2)	☒	Must be OFF (factory default)	Can not communicate between Indoor & Outdoor unit (System will not be operated)	
MULTI V IV MULTI V 5	Gen. 4 (ARNU*4)	☒	Must be ON to enable gen. 4 functions	When Dip Switch No.3 is OFF, System can be operated, but some function of Gen. 4 is not available	
	Gen. 2 + Gen. 4	☒	Must be OFF (factory default)	When Dip Switch No.3 is ON, Can not communicate between Gen. 2 Indoor & Outdoor unit (Gen 2 units are not operated), only Gen 4 Units are operated.	Some functions of Gen.4 are not available

※○ : Applied, - : Not Applied

ODU dip switch setting procedure (No.3)

ODU main PCB dip switch is all "OFF" at default state

- (1) Check and make sure that all connected indoor units are 4 series. (ARNU*****4.)
- (2) Change Dip switch No. 3 from OFF ☒ ON
- (3) Push the reset button.

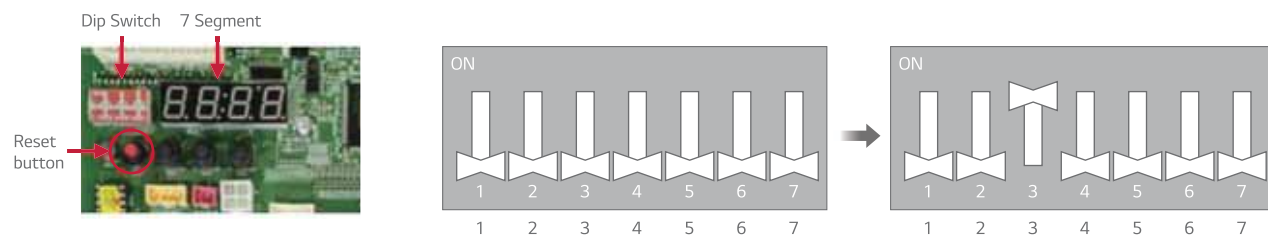

MULTI V 5 Q&A

Q3 How does MULTI V 5 operate when humidity reference of the dual sensing SLC is that of the outdoor?

A3 During dual sensing SLC, outdoor unit changes target pressure of the system referring to temperature and humidity in cooling mode.
 - When the humidity of outdoor side is higher than that of indoor side, outdoor unit will lower target pressure to remove humidity, thus outdoor unit will consume more energy and indoor will be more cooled compared to SLC operation but more efficiency than normal operation.

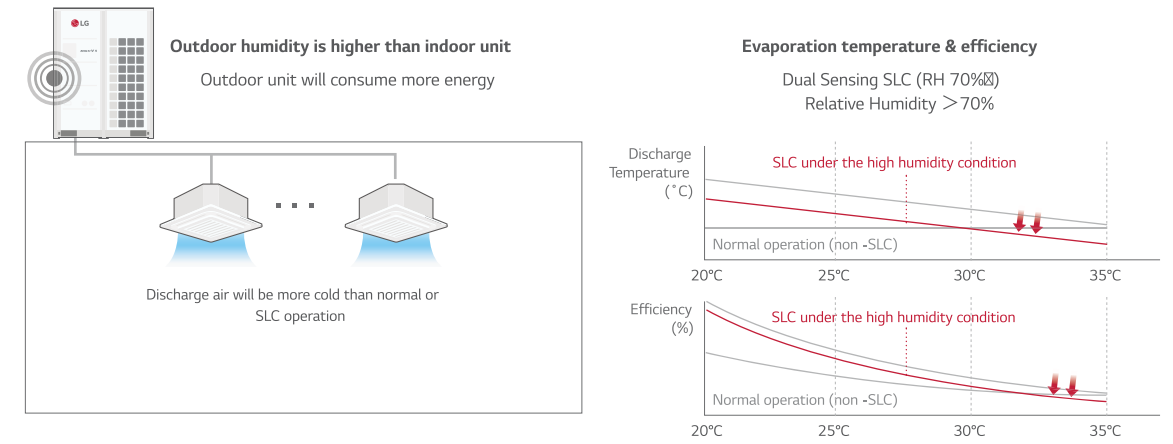

- When the humidity of outdoor side is lower than that of indoor side, outdoor unit will rise target pressure to save energy and keep comfort, but indoor humidity will be less removed compared to normal operation.

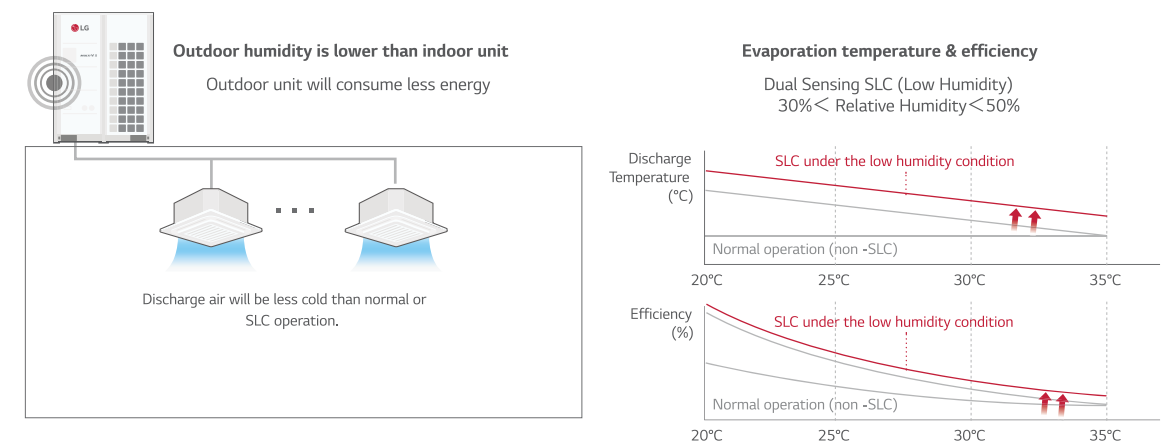

To maximize comfort and energy efficiency, the outdoor unit's humidity sensing can be turned off or a standard remote control can be installed to sense indoor humidity.

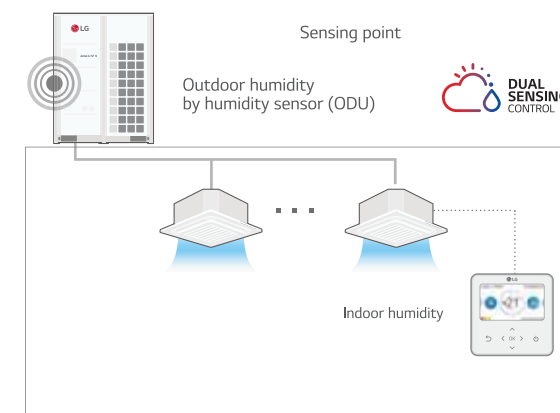

SLC Setting

CASE 1. Dual Sensing SLC with Outdoor humidity sensor in ODU Setting

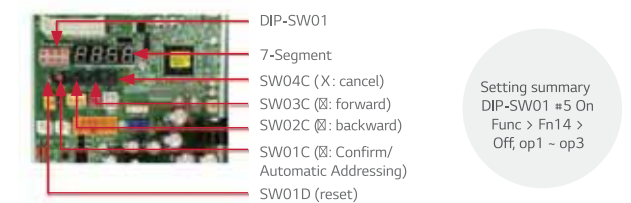

CASE 2. Dual Sensing SLC with Indoor humidity sensor in New Standard R/C setting (PREMTB100)



☒ User can turn off humidity control in ODU Setting (humidity reference)
 <Setting summary> ODU DIP-SW01 = 5 On > Func > Fn16 > Off

MULTI V 5 Q&A

Q4 What is the principle and accuracy of humidity sensor?

A4 Total Tolerance (%) = Sensor measurement tolerance (%) + Location of sensor tolerance (%)

The capacitive measurement principle established and proved itself as a standard in the past. For this principle, the sensor element is built out of a capacitor. The dielectric is a polymer which absorbs or releases water proportional to the relative environmental humidity, and thus changes the capacitance of the capacitor. This change in capacitance can be measured by an electronic circuit. For humidity sensors with CMOSens[®] technology, a "micro-machined" finger electrode system with different protective and polymer cover layers forms the capacitance for the sensor chip, and, in addition to providing the sensor property, simultaneously protects the sensor from interference in ways previously not achieved.

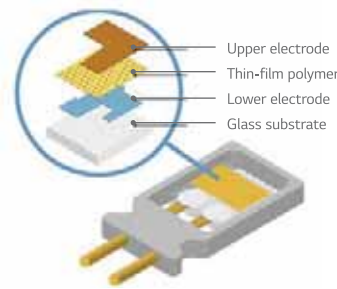

Model	Humidity Sensor of Outdoor	Humidity Sensor of R/Controller
Size (mm)	3 x 3 x 1.1	2.5 x 2.5 x 0.9
Supply voltage range	2.1 to 3.6 V	2.4 to 5.5 V
RH operating range	0 - 100% RH	0 - 100% RH
T operating range	-40 to +125°C (-40 to +257°F)	-40 to +125°C (-40 to +257°F)
RH response time	8 sec (tau 63%)	8 sec (tau 63%)

MULTI V 5 Q&A

Other Questions

Item	Question	Answer
Fan	The static pressure of MULTI V 5 is max. 8 mmAq as MULTI V IV??	Yes, the static pressure of MULTI V 5 is the same as MULTI V IV.
Compressor	Is the limitation of Compressor max. Hz applied by the capacity of outdoor unit?	No, the limitation of comp Hz is not applied for default. But, it can be set by option for limitation of max. Hz (or current).
VI	In case of vapor injection, how much is the middle pressure?	The optimal middle pressure for vapor injection is 1.2 P _s *. *P _s : Suction pressure of compressor.
VI	By how much is heating capacity increased by vapor injection?	Generally, the heating capacity is increased up to 15 - 20%.
Humidity Sensor	Where is Indoor Humidity sensor?	It is placed inside of the RS3 remote controller.
Remote Controller	Does remote controller show the humidity information (Status) as well?	Yes. It shows the current humidity information on screen. (for RS3 Only) But has no function to control the humidity.
Remote Controller	Is it possible to connect the local humidity sensor with Remote controller (RS3)?	No. All of RS3 remote controller can not be connected with local humidity sensor.
SLC	Does dual sensing SLC function control the humidity ratio?	No. There is no control of humidity ratio.
SLC	Is SLC fully used on Eurovent? Isn't humidity fixed for the test? What about AHRI?	Eurovent (RH 47%) and AHRI (RH 51%) have fixed humidity test condition.
Comfort Cooling	Why is not the comfort heating applied in product?	Comfort cooling need super heating controlled and Comfort heating need sub cooling controlled. In case of controlling EEV for sub cooling, noise and stable operation may be affected and critical.
Installation	Does the IDU - Central controller direct connection for communication cable is possible? (Flat connection)	No, it is not possible.

MULTI V™ 5

- Air Cooled VRF Heat Pump
- 22.4kW ~ 268.8kW (Cooling capacity based)
- 3Ø, 380 ~ 415V, 50Hz
- Top discharge outdoor unit

1,000M
TOTAL PIPING LENGTH

Design
For
The Ultimate

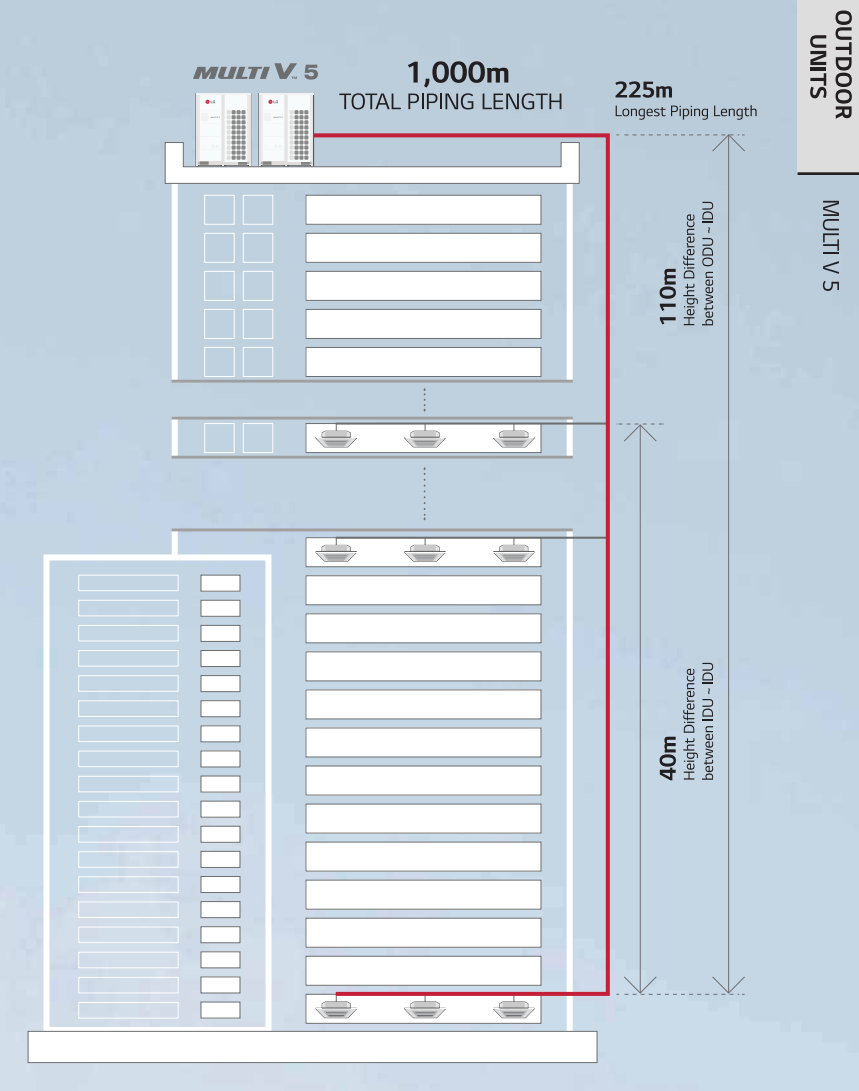

Energy savings



Reliability



Low noise



Advanced performance

How does it work?

Dual Sensing



Partial Defrost



MULTI V 5

ARUN080LTE5 / ARUN100LTE5
ARUN120LTE5 / ARUN140LTE5



HP			8	10	12	14	
Model Name	Combination Unit		ARUN080LTE5	ARUN100LTE5	ARUN120LTE5	ARUN140LTE5	
	Independent Unit		ARUN080LTE5	ARUN100LTE5	ARUN120LTE5	ARUN140LTE5	
Capacity	Cooling (Rated)	kW	22.4	28.0	33.6	39.2	
		Btu/h	76,400	95,500	114,600	133,800	
	Heating (Rated)	kW	25.2	31.5	37.8	44.1	
		Btu/h	86,000	107,500	129,000	150,500	
Input	Cooling (Rated)	kW	4.59	5.70	7.91	9.12	
	Heating (Rated)	kW	4.74	5.78	8.06	9.78	
EER (Rated)			4.88	4.91	4.25	4.30	
COP (Rated)			5.32	5.45	4.69	4.51	
Power Factor	Rated	-	0.93	0.93	0.93	0.93	
Exterior	Color		Warm Gray / Dawn Gray	Warm Gray / Dawn Gray	Warm Gray / Dawn Gray	Warm Gray / Dawn Gray	
	RAL code		NL503K / NA507K	NL503K / NA507K	NL503K / NA507K	NL503K / NA507K	
Heat Exchanger			Wide Louver Plus	Wide Louver Plus	Wide Louver Plus	Wide Louver Plus	
Compressor	Motor Output x Number	W x No.	5,300 x 1	5,300 x 1	5,300 x 1	5,300 x 1	
	Type		Propeller fan	Propeller fan	Propeller fan	Propeller fan	
Fan	Motor Output x Number	W	1,200 x 1	1,200 x 1	1,200 x 1	900 x 2	
	Air Flow Rate (High)		m ³ /min	240 x 1	240 x 1	240 x 1	320 x 1
			ft ³ /min	8,476 x 1	8,476 x 1	8,476 x 1	11,301 x 1
	External Static Pressure (Max, Pa)			80	80	80	80
	Drive			DC INVERTER	DC INVERTER	DC INVERTER	DC INVERTER
	Discharge		Side / Top	TOP	TOP	TOP	TOP
Pipe Connections	Liquid Pipe	mm (inch)	9.52 (3/8)	9.52 (3/8)	12.7 (1/2)	12.7 (1/2)	
	Gas Pipe	mm (inch)	19.05 (3/4)	22.2 (7/8)	28.58 (1-1/8)	28.58 (1-1/8)	
Dimensions (W x H x D)		mm x No.	(930 x 1,690 x 760) x 1	(930 x 1,690 x 760) x 1	(930 x 1,690 x 760) x 1	(1,240 x 1,690 x 760) x 1	
Net Weight			kg	188 x 1	188 x 1	220 x 1	
			lbs	414 x 1	414 x 1	485 x 1	
Sound Pressure Level	Cooling	dB(A)	58.0	58.0	59.0	60.0	
	Heating	dB(A)	59.0	59.0	60.0	61.0	
Communication Cable		mm ² x No. (VCTF-SB)	1.0 - 1.5 x 2C	1.0 - 1.5 x 2C	1.0 - 1.5 x 2C	1.0 - 1.5 x 2C	
Refrigerant	Refrigerant name		R410A	R410A	R410A	R410A	
	Precharged Amount in factory	kg	10.0	10.0	10.0	13.0	
		lbs	22.0	22.0	22.0	28.7	
	t-CO ₂ eq			20.9	20.9	27.1	
	Control			Electronic Expansion Valve	Electronic Expansion Valve	Electronic Expansion Valve	Electronic Expansion Valve
Power Supply	Ø, V, Hz		3, 380-415, 50	3, 380-415, 50	3, 380-415, 50	3, 380-415, 50	
Number of maximum connectable indoor units			13 (20)	16 (25)	20 (30)	23 (35)	

- Note
- Due to our policy of innovation some specifications may be changed without notification.
 - Wiring cable size must comply with the applicable local and national codes. And "Electric characteristics" chapter should be considered for electrical work and design. Especially the power cable and circuit breaker should be selected in accordance with that.
 - Power factor could vary less than ±1% according to the operating conditions.
 - Sound pressure level is measured on the rated condition in the anechoic rooms by ISO 3745 standard. Sound power level is measured on the rated condition in the reverberation rooms by ISO 3741 standard. Therefore, these values can be increased owing to ambient conditions during operation.
 - Performances are based on the following conditions :
*Cooling : Indoor Ambient Temp. 27°CDB / 19°CWB, Outdoor Ambient Temp. 35°CDB / 24°CWB
*Heating : Indoor Ambient Temp. 20°CDB / 15°CWB, Outdoor Ambient Temp. 7°CDB / 6°CWB
Interconnected Pipe Length is 7.5m and difference of Elevation (Outdoor - Indoor Unit) is Zero.
 - The numbers in parentheses means maximum connectable indoor units in accordance with outdoor units combination. The recommended ratio is 130%.
 - This product contains Fluorinated greenhouse gases. (R410A, GWP(Global warming potential) = 2087.5)

MULTI V 5

ARUN160LTE5 / ARUN180LTE5
ARUN200LTE5 / ARUN220LTE5



HP			16	18	20	22	
Model Name	Combination Unit		ARUN160LTE5	ARUN180LTE5	ARUN200LTE5	ARUN220LTE5	
	Independent Unit		ARUN160LTE5	ARUN180LTE5	ARUN200LTE5	ARUN220LTE5	
Capacity	Cooling (Rated)	kW	44.8	50.4	56.0	61.6	
		Btu/h	152,900	172,000	191,100	210,200	
	Heating (Rated)	kW	50.4	56.7	63.0	69.3	
		Btu/h	172,000	193,500	215,000	236,500	
Input	Cooling (Rated)	kW	10.80	10.96	12.31	14.84	
	Heating (Rated)	kW	11.59	12.06	15.52	17.54	
EER (Rated)			4.15	4.60	4.55	4.15	
COP (Rated)			4.35	4.70	4.06	3.95	
Power Factor	Rated	-	0.93	0.93	0.93	0.93	
Exterior	Color		Warm Gray / Dawn Gray	Warm Gray / Dawn Gray	Warm Gray / Dawn Gray	Warm Gray / Dawn Gray	
	RAL code		NL503K / NA507K	NL503K / NA507K	NL503K / NA507K	NL503K / NA507K	
Heat Exchanger			Wide Louver Plus	Wide Louver Plus	Wide Louver Plus	Wide Louver Plus	
Compressor	Motor Output x Number	W x No.	5,300 x 1	5,300 x 1 + 4,200 x 1	5,300 x 2	5,300 x 2	
	Type		Propeller fan	Propeller fan	Propeller fan	Propeller fan	
Fan	Motor Output x Number	W	900 x 2	900 x 2	900 x 2	900 x 2	
	Air Flow Rate (High)		m ³ /min	320 x 1	320 x 1	320 x 1	320 x 1
			ft ³ /min	11,301 x 1	11,301 x 1	11,301 x 1	11,301 x 1
	External Static Pressure (Max, Pa)			80	80	80	80
	Drive			DC INVERTER	DC INVERTER	DC INVERTER	DC INVERTER
	Discharge		Side / Top	TOP	TOP	TOP	TOP
Pipe Connections	Liquid Pipe	mm (inch)	12.7 (1/2)	15.88 (5/8)	15.88 (5/8)	15.88 (5/8)	
	Gas Pipe	mm (inch)	28.58 (1-1/8)	28.58 (1-1/8)	28.58 (1-1/8)	28.58 (1-1/8)	
Dimensions (W x H x D)		mm x No.	(1,240 x 1,690 x 760) x 1	(1,240 x 1,690 x 760) x 1	(1,240 x 1,690 x 760) x 1	(1,240 x 1,690 x 760) x 1	
Net Weight			kg	220 x 1	260 x 1	274 x 1	
			lbs	485 x 1	573 x 1	604 x 1	
Sound Pressure Level	Cooling	dB(A)	60.5	61.0	62.0	64.5	
	Heating	dB(A)	61.5	62.0	64.5	65.5	
Communication Cable		mm ² x No. (VCTF-SB)	1.0 - 1.5 x 2C	1.0 - 1.5 x 2C	1.0 - 1.5 x 2C	1.0 - 1.5 x 2C	
Refrigerant	Refrigerant name		R410A	R410A	R410A	R410A	
	Precharged Amount in factory	kg	13.0	13.0	14.0	14.0	
		lbs	28.7	28.7	30.9	30.9	
	t-CO ₂ eq			27.1	27.1	29.2	
	Control			Electronic Expansion Valve	Electronic Expansion Valve	Electronic Expansion Valve	Electronic Expansion Valve
Power Supply	Ø, V, Hz		3, 380-415, 50	3, 380-415, 50	3, 380-415, 50	3, 380-415, 50	
Number of maximum connectable indoor units			26 (40)	29 (45)	32 (50)	35 (56)	

- Note
- Due to our policy of innovation some specifications may be changed without notification.
 - Wiring cable size must comply with the applicable local and national codes. And "Electric characteristics" chapter should be considered for electrical work and design. Especially the power cable and circuit breaker should be selected in accordance with that.
 - Power factor could vary less than ±1% according to the operating conditions.
 - Sound pressure level is measured on the rated condition in the anechoic rooms by ISO 3745 standard. Sound power level is measured on the rated condition in the reverberation rooms by ISO 3741 standard. Therefore, these values can be increased owing to ambient conditions during operation.
 - Performances are based on the following conditions :
*Cooling : Indoor Ambient Temp. 27°CDB / 19°CWB, Outdoor Ambient Temp. 35°CDB / 24°CWB
*Heating : Indoor Ambient Temp. 20°CDB / 15°CWB, Outdoor Ambient Temp. 7°CDB / 6°CWB
Interconnected Pipe Length is 7.5m and difference of Elevation (Outdoor - Indoor Unit) is Zero.
 - The numbers in parentheses means maximum connectable indoor units in accordance with outdoor units combination. The recommended ratio is 130%.
 - This product contains Fluorinated greenhouse gases. (R410A, GWP(Global warming potential) = 2087.5)

MULTI V 5

ARUN240LTE5 / ARUN260LTE5



HP			24	26
Model Name	Combination Unit		ARUN240LTE5	ARUN260LTE5
	Independent Unit		ARUN240LTE5	ARUN260LTE5
Capacity	Cooling (Rated)	kW	67.2	72.8
		Btu/h	229,300	248,400
	Heating (Rated)	kW	74.3	74.3
		Btu/h	253,400	253,400
Input	Cooling (Rated)	kW	16.76	19.41
	Heating (Rated)	kW	18.85	19.49
EER (Rated)			4.01	3.75
COP (Rated)			3.94	3.81
Power Factor	Rated	-	0.93	0.93
Exterior	Color		Warm Gray / Dawn Gray	Warm Gray / Dawn Gray
	RAL code		NL503K / NA507K	NL503K / NA507K
Heat Exchanger			Wide Louver Plus	Wide Louver Plus
Compressor	Motor Output x Number	W x No.	5,300 x 2	5,300 x 2
	Type		Propeller fan	Propeller fan
Fan	Motor Output x Number	W	900 x 2	900 x 2
	Air Flow Rate (High)	m ³ /min	320 x 1	320 x 1
		ft ³ /min	11,301 x 1	11,301 x 1
	External Static Pressure (Max, Pa)		80	80
	Drive		DC INVERTER	DC INVERTER
	Discharge		Side / Top	TOP
Pipe Connections	Liquid Pipe	mm (inch)	15.88 (5/8)	19.05 (3/4)
	Gas Pipe	mm (inch)	34.9 (1-3/8)	34.9 (1-3/8)
Dimensions (W x H x D)		mm x No.	(1,240 x 1,690 x 760) x 1	(1,240 x 1,690 x 760) x 1
Net Weight			kg	276 x 1
			lbs	608 x 1
Sound Pressure Level	Cooling	dB(A)	65.0	65.0
	Heating	dB(A)	67.0	67.0
Communication Cable		mm ² x No. (VCTF-SB)	1.0 - 1.5 x 2C	1.0 - 1.5 x 2C
Refrigerant	Refrigerant name		R410A	R410A
	Precharged Amount in factory	kg	16.0	16.0
		lbs	35.3	35.3
	t-CO ₂ eq		33.4	33.4
Control		Electronic Expansion Valve	Electronic Expansion Valve	
Power Supply	Ø, V, Hz		3, 380-415, 50	3, 380-415, 50
Number of maximum connectable indoor units			39 (61)	42 (64)

- Note
- Due to our policy of innovation some specifications may be changed without notification.
 - Wiring cable size must comply with the applicable local and national codes. And "Electric characteristics" chapter should be considered for electrical work and design. Especially the power cable and circuit breaker should be selected in accordance with that.
 - Power factor could vary less than ±1% according to the operating conditions.
 - Sound pressure level is measured on the rated condition in the anechoic rooms by ISO 3745 standard. Sound power level is measured on the rated condition in the reverberation rooms by ISO 3741 standard. Therefore, these values can be increased owing to ambient conditions during operation.
 - Performances are based on the following conditions :
 *Cooling : Indoor Ambient Temp. 27°CDB / 19°CWB, Outdoor Ambient Temp. 35°CDB / 24°CWB
 *Heating : Indoor Ambient Temp. 20°CDB / 15°CWB, Outdoor Ambient Temp. 7°CDB / 6°CWB
 Interconnected Pipe Length is 7.5m and difference of Elevation (Outdoor - Indoor Unit) is Zero.
 - The numbers in parentheses means maximum connectable indoor units in accordance with outdoor units combination. The recommended ratio is 130%.
 - This product contains Fluorinated greenhouse gases. (R410A, GWP(Global warming potential) = 2087.5)

MULTI V 5

ARUN221LTE5 / ARUN241LTE5



HP			22'	24'
Model Name	Combination Unit		ARUN221LTE5	ARUN241LTE5
	Independent Unit		ARUN120LTE5 ARUN100LTE5	ARUN120LTE5 ARUN120LTE5
Capacity	Cooling (Rated)	kW	61.6	67.2
		Btu/h	210,100	229,200
	Heating (Rated)	kW	69.3	75.6
		Btu/h	236,500	258,000
Input	Cooling (Rated)	kW	13.60	15.81
	Heating (Rated)	kW	13.80	16.12
EER (Rated)			4.53	4.25
COP (Rated)			5.01	4.69
Power Factor	Rated	-	0.93	0.93
Exterior	Color		Warm Gray / Dawn Gray	Warm Gray / Dawn Gray
	RAL code		NL503K / NA507K	NL503K / NA507K
Heat Exchanger			Wide Louver Plus	Wide Louver Plus
Compressor	Motor Output x Number	W x No.	5,300 x 2	5,300 x 2
	Type		Propeller fan	Propeller fan
Fan	Motor Output x Number	W	(1,200 x 1) + (1,200 x 1)	(1,200 x 1) + (1,200 x 1)
	Air Flow Rate (High)	m ³ /min	(240 x 1) + (240 x 1)	(240 x 1) + (240 x 1)
		ft ³ /min	(8,476 x 1) + (8,476 x 1)	(8,476 x 1) + (8,476 x 1)
	External Static Pressure (Max, Pa)		80	80
	Drive		DC INVERTER	DC INVERTER
	Discharge		Side / Top	TOP
Pipe Connections	Liquid Pipe	mm (inch)	15.88 (5/8)	15.88 (5/8)
	Gas Pipe	mm (inch)	28.58 (1-1/8)	34.9 (1-3/8)
Dimensions (W x H x D)		mm x No.	(930 x 1,690 x 760) x 2	(930 x 1,690 x 760) x 2
Net Weight			kg	203 x 2
			lbs	414 x 2
Sound Pressure Level	Cooling	dB(A)	61.5	62.0
	Heating	dB(A)	62.5	63.0
Communication Cable		mm ² x No. (VCTF-SB)	1.0 - 1.5 x 2C	1.0 - 1.5 x 2C
Refrigerant	Refrigerant name		R410A	R410A
	Precharged Amount in factory	kg	10.0 + 10.0	10.0 + 10.0
		lbs	22.0 + 22.0	22.0 + 22.0
	t-CO ₂ eq		41.8	41.8
Control		Electronic Expansion Valve	Electronic Expansion Valve	
Power Supply	Ø, V, Hz		3, 380-415, 50	3, 380-415, 50
Number of maximum connectable indoor units			35 (44)	39 (48)

- Note
- Due to our policy of innovation some specifications may be changed without notification.
 - Wiring cable size must comply with the applicable local and national codes. And "Electric characteristics" chapter should be considered for electrical work and design. Especially the power cable and circuit breaker should be selected in accordance with that.
 - Power factor could vary less than ±1% according to the operating conditions.
 - Sound pressure level is measured on the rated condition in the anechoic rooms by ISO 3745 standard. Sound power level is measured on the rated condition in the reverberation rooms by ISO 3741 standard. Therefore, these values can be increased owing to ambient conditions during operation.
 - Performances are based on the following conditions :
 *Cooling : Indoor Ambient Temp. 27°CDB / 19°CWB, Outdoor Ambient Temp. 35°CDB / 24°CWB
 *Heating : Indoor Ambient Temp. 20°CDB / 15°CWB, Outdoor Ambient Temp. 7°CDB / 6°CWB
 Interconnected Pipe Length is 7.5m and difference of Elevation (Outdoor - Indoor Unit) is Zero.
 - The numbers in parentheses means maximum connectable indoor units in accordance with outdoor units combination. The recommended ratio is 130%.
 - This product contains Fluorinated greenhouse gases. (R410A, GWP(Global warming potential) = 2087.5)

MULTI V 5

ARUN261LTE5 / ARUN280LTE5
ARUN300LTE5 / ARUN320LTE5



HP		26'	28	30	32	
Model Name	Combination Unit	ARUN261LTE5	ARUN280LTE5	ARUN300LTE5	ARUN320LTE5	
	Independent Unit	ARUN140LTE5 ARUN120LTE5	ARUN160LTE5 ARUN120LTE5	ARUN180LTE5 ARUN120LTE5	ARUN200LTE5 ARUN120LTE5	
Capacity	Cooling (Rated)	kW	72.8	78.4	84.0	89.6
		Btu/h	248,400	267,500	286,600	305,700
	Heating (Rated)	kW	81.9	88.2	94.5	100.8
		Btu/h	279,500	301,000	322,500	344,000
Input	Cooling (Rated)	kW	17.02	18.70	18.86	20.21
	Heating (Rated)	kW	17.84	19.65	20.12	23.58
EER (Rated)		4.28	4.19	4.45	4.43	
COP (Rated)		4.59	4.49	4.70	4.28	
Power Factor	Rated	-	0.93	0.93	0.93	
Exterior	Color	Warm Gray / Dawn Gray	Warm Gray / Dawn Gray	Warm Gray / Dawn Gray	Warm Gray / Dawn Gray	
	RAL code	NL503K / NA507K	NL503K / NA507K	NL503K / NA507K	NL503K / NA507K	
Heat Exchanger		Wide Louver Plus	Wide Louver Plus	Wide Louver Plus	Wide Louver Plus	
Compressor	Motor Output x Number	W x No.	5,300 x 2	5,300 x 2	(5,300 x 2) + (4,200 x 1)	(5,300 x 2) + (4,200 x 1)
	Type		Propeller fan	Propeller fan	Propeller fan	Propeller fan
Fan	Motor Output x Number	W	(900 x 2) + (1,200 x 1)	(900 x 2) + (1,200 x 1)	(900 x 2) + (1,200 x 1)	(900 x 2) + (1,200 x 1)
	Air Flow Rate (High)	m³/min	(320 x 1) + (240 x 1)	(320 x 1) + (240 x 1)	(320 x 1) + (240 x 1)	(320 x 1) + (240 x 1)
		ft³/min	(11,301 x 1) + (8,476 x 1)	(11,301 x 1) + (8,476 x 1)	(11,301 x 1) + (8,476 x 1)	(11,301 x 1) + (8,476 x 1)
	External Static Pressure (Max, Pa)		80	80	80	80
	Drive		DC INVERTER	DC INVERTER	DC INVERTER	DC INVERTER
	Discharge	Side / Top	TOP	TOP	TOP	TOP
Pipe Connections	Liquid Pipe	mm (inch)	19.05 (3/4)	19.05 (3/4)	19.05 (3/4)	19.05 (3/4)
	Gas Pipe	mm (inch)	34.9 (1-3/8)	34.9 (1-3/8)	34.9 (1-3/8)	34.9 (1-3/8)
Dimensions (W x H x D)	mm x No.	(1,240 x 1,690 x 760) x 1 (930 x 1,690 x 760) x 1	(1,240 x 1,690 x 760) x 1 (930 x 1,690 x 760) x 1	(1,240 x 1,690 x 760) x 1 (930 x 1,690 x 760) x 1	(1,240 x 1,690 x 760) x 1 (930 x 1,690 x 760) x 1	
Net Weight	kg	(220 x 1) + (188 x 1)	(220 x 1) + (188 x 1)	(260 x 1) + (188 x 1)	(274 x 1) + (188 x 1)	
	lbs	(485 x 1) + (414 x 1)	(485 x 1) + (414 x 1)	(573 x 1) + (414 x 1)	(604 x 1) + (414 x 1)	
Sound Pressure Level	Cooling	dB(A)	62.5	62.8	63.1	63.8
	Heating	dB(A)	63.5	63.8	64.1	65.8
Communication Cable	mm² x No. (VCTF-SB)	1.0 - 1.5 x 2C	1.0 - 1.5 x 2C	1.0 - 1.5 x 2C	1.0 - 1.5 x 2C	
Refrigerant	Refrigerant name		R410A	R410A	R410A	R410A
	Precharged Amount in factory	kg	13.0 + 10.0	13.0 + 10.0	13.0 + 10.0	14.0 + 10.0
		lbs	28.7 + 22.0	28.7 + 22.0	28.7 + 22.0	30.9 + 22.0
	t-CO ₂ eq		48.0	48.0	48.0	50.1
Control		Electronic Expansion Valve	Electronic Expansion Valve	Electronic Expansion Valve	Electronic Expansion Valve	
Power Supply	Ø, V, Hz	3, 380-415, 50	3, 380-415, 50	3, 380-415, 50	3, 380-415, 50	
Number of maximum connectable indoor units		42 (52)	45 (56)	49 (60)	52 (64)	

- Note
- Due to our policy of innovation some specifications may be changed without notification.
 - Wiring cable size must comply with the applicable local and national codes. And "Electric characteristics" chapter should be considered for electrical work and design. Especially the power cable and circuit breaker should be selected in accordance with that.
 - Power factor could vary less than ±1% according to the operating conditions.
 - Sound pressure level is measured on the rated condition in the anechoic rooms by ISO 3745 standard. Sound power level is measured on the rated condition in the reverberation rooms by ISO 3741 standard. Therefore, these values can be increased owing to ambient conditions during operation.
 - Performances are based on the following conditions:
 - *Cooling : Indoor Ambient Temp. 27°CDB / 19°CWB, Outdoor Ambient Temp. 35°CDB / 24°CWB
 - *Heating : Indoor Ambient Temp. 20°CDB / 15°CWB, Outdoor Ambient Temp. 7°CDB / 6°CWB
 - Interconnected Pipe Length is 7.5m and difference of Elevation (Outdoor - Indoor Unit) is Zero.
 - The numbers in parentheses means maximum connectable indoor units in accordance with outdoor units combination. The recommended ratio is 130%.
 - This product contains Fluorinated greenhouse gases. (R410A, GWP(Global warming potential) = 2087.5)

MULTI V 5

ARUN340LTE5 / ARUN360LTE5
ARUN380LTE5 / ARUN400LTE5



HP		34	36	38	40	
Model Name	Combination Unit	ARUN340LTE5	ARUN360LTE5	ARUN380LTE5	ARUN400LTE5	
	Independent Unit	ARUN220LTE5 ARUN120LTE5	ARUN240LTE5 ARUN120LTE5	ARUN240LTE5 ARUN140LTE5	ARUN240LTE5 ARUN160LTE5	
Capacity	Cooling (Rated)	kW	95.2	100.8	106.4	112.0
		Btu/h	324,800	343,900	363,100	382,200
	Heating (Rated)	kW	107.1	112.1	118.4	124.7
		Btu/h	365,500	382,400	403,900	425,400
Input	Cooling (Rated)	kW	22.75	24.66	25.87	27.55
	Heating (Rated)	kW	25.60	26.91	28.62	30.43
EER (Rated)		4.18	4.09	4.11	4.06	
COP (Rated)		4.18	4.16	4.13	4.10	
Power Factor	Rated	-	0.93	0.93	0.93	
Exterior	Color	Warm Gray / Dawn Gray	Warm Gray / Dawn Gray	Warm Gray / Dawn Gray	Warm Gray / Dawn Gray	
	RAL code	NL503K / NA507K	NL503K / NA507K	NL503K / NA507	NL503K / NA507K	
Heat Exchanger		Wide Louver Plus	Wide Louver Plus	Wide Louver Plus	Wide Louver Plus	
Compressor	Motor Output x Number	W x No.	5,300 x 3	5,300 x 3	5,300 x 3	5,300 x 3
	Type		Propeller fan	Propeller fan	Propeller fan	Propeller fan
Fan	Motor Output x Number	W	(900 x 2) + (1,200 x 1)	(900 x 2) + (1,200 x 1)	900 x 4	900 x 4
	Air Flow Rate (High)	m³/min	(320 x 1) + (240 x 1)	(320 x 1) + (240 x 1)	320 x 2	320 x 2
		ft³/min	(11,301 x 1) + (8,476 x 1)	(11,301 x 1) + (8,476 x 1)	11,301 x 2	11,301 x 2
	External Static Pressure (Max, Pa)		80	80	80	80
	Drive		DC INVERTER	DC INVERTER	DC INVERTER	DC INVERTER
	Discharge	Side / Top	TOP	TOP	TOP	TOP
Pipe Connections	Liquid Pipe	mm (inch)	19.05 (3/4)	19.05 (3/4)	19.05 (3/4)	19.05 (3/4)
	Gas Pipe	mm (inch)	34.9 (1-3/8)	41.3 (1-5/8)	41.3 (1-5/8)	41.3 (1-5/8)
Dimensions (W x H x D)	mm x No.	(1,240 x 1,690 x 760) x 1 (930 x 1,690 x 760) x 1	(1,240 x 1,690 x 760) x 1 (930 x 1,690 x 760) x 1	(1,240 x 1,690 x 760) x 2	(1,240 x 1,690 x 760) x 2	
Net Weight	kg	(274 x 1) + (188 x 1)	(276 x 1) + (188 x 1)	(276 x 1) + (220 x 1)	(276 x 1) + (220 x 1)	
	lbs	(604 x 1) + (414 x 1)	(608 x 1) + (414 x 1)	(608 x 1) + (485 x 1)	(608 x 1) + (485 x 1)	
Sound Pressure Level	Cooling	dB(A)	65.6	66.0	66.2	66.3
	Heating	dB(A)	66.6	67.8	68.0	68.1
Communication Cable	mm² x No. (VCTF-SB)	1.0 - 1.5 x 2C	1.0 - 1.5 x 2C	1.0 - 1.5 x 2C	1.0 - 1.5 x 2C	
Refrigerant	Refrigerant name		R410A	R410A	R410A	R410A
	Precharged Amount in factory	kg	14.0 + 10.0	16.0 + 10.0	16.0 + 13.0	16.0 + 13.0
		lbs	30.9 + 22.0	35.3 + 22.0	35.3 + 28.7	35.3 + 28.7
	t-CO ₂ eq		50.1	54.3	60.5	60.5
Control		Electronic Expansion Valve	Electronic Expansion Valve	Electronic Expansion Valve	Electronic Expansion Valve	
Power Supply	Ø, V, Hz	3, 380-415, 50	3, 380-415, 50	3, 380-415, 50	3, 380-415, 50	
Number of maximum connectable indoor units		55 (64)	58 (64)	61 (64)	64	

- Note
- Due to our policy of innovation some specifications may be changed without notification.
 - Wiring cable size must comply with the applicable local and national codes. And "Electric characteristics" chapter should be considered for electrical work and design. Especially the power cable and circuit breaker should be selected in accordance with that.
 - Power factor could vary less than ±1% according to the operating conditions.
 - Sound pressure level is measured on the rated condition in the anechoic rooms by ISO 3745 standard. Sound power level is measured on the rated condition in the reverberation rooms by ISO 3741 standard. Therefore, these values can be increased owing to ambient conditions during operation.
 - Performances are based on the following conditions:
 - *Cooling : Indoor Ambient Temp. 27°CDB / 19°CWB, Outdoor Ambient Temp. 35°CDB / 24°CWB
 - *Heating : Indoor Ambient Temp. 20°CDB / 15°CWB, Outdoor Ambient Temp. 7°CDB / 6°CWB
 - Interconnected Pipe Length is 7.5m and difference of Elevation (Outdoor - Indoor Unit) is Zero.
 - The numbers in parentheses means maximum connectable indoor units in accordance with outdoor units combination. The recommended ratio is 130%.
 - This product contains Fluorinated greenhouse gases. (R410A, GWP(Global warming potential) = 2087.5)

MULTI V 5

ARUN420LTE5 / ARUN440LTE5
ARUN460LTE5 / ARUN480LTE5



HP			42	44	46	48
Model Name	Combination Unit		ARUN420LTE5	ARUN440LTE5	ARUN460LTE5	ARUN480LTE5
	Independent Unit		ARUN240LTE5 ARUN180LTE5	ARUN240LTE5 ARUN200LTE5	ARUN240LTE5 ARUN220LTE5	ARUN240LTE5 ARUN240LTE5
Capacity	Cooling (Rated)	kW	117.6	123.2	128.8	134.4
		Btu/h	401,300	420,400	439,500	458,600
	Heating (Rated)	kW	131.0	137.3	143.6	148.5
		Btu/h	446,900	468,400	489,900	506,800
Input	Cooling (Rated)	kW	27.71	29.07	31.60	33.52
	Heating (Rated)	kW	30.91	34.36	36.39	37.69
EER (Rated)			4.24	4.24	4.08	4.01
COP (Rated)			4.24	3.99	3.94	3.94
Power Factor	Rated	-	0.93	0.93	0.93	0.93
Exterior	Color		Warm Gray / Dawn Gray	Warm Gray / Dawn Gray	Warm Gray / Dawn Gray	Warm Gray / Dawn Gray
	RAL code		NL503K / NA507K	NL503K / NA507K	NL503K / NA507K	NL503K / NA507K
Heat Exchanger			Wide Louver Plus	Wide Louver Plus	Wide Louver Plus	Wide Louver Plus
Compressor	Motor Output x Number	W x No.	(5,300 x 3) + (4,200 x 1)	5,300 x 4	5,300 x 4	5,300 x 4
	Type		Propeller fan	Propeller fan	Propeller fan	Propeller fan
Fan	Motor Output x Number	W	900 x 4	900 x 4	900 x 4	900 x 4
	Air Flow Rate (High)	m³/min	320 x 2	320 x 2	320 x 2	320 x 2
		ft³/min	11,301 x 2	11,301 x 2	11,301 x 2	11,301 x 2
	External Static Pressure (Max, Pa)			80	80	80
	Drive			DC INVERTER	DC INVERTER	DC INVERTER
	Discharge		Side / Top	TOP	TOP	TOP
Pipe Connections	Liquid Pipe	mm (inch)	19.05 (3/4)	19.05 (3/4)	19.05 (3/4)	19.05 (3/4)
	Gas Pipe	mm (inch)	41.3 (1-5/8)	41.3 (1-5/8)	41.3 (1-5/8)	41.3 (1-5/8)
Dimensions (W x H x D)		mm x No.	(1,240 x 1,690 x 760) x 2 (276 x 1) + (260 x 1)	(1,240 x 1,690 x 760) x 2 (276 x 1) + (274 x 1)	(608 x 1) + (604 x 1) (276 x 1) + (274 x 1)	608 x 2 276 x 2
Net Weight		kg	(608 x 1) + (573 x 1)	(608 x 1) + (604 x 1)	(639 x 1) + (635 x 1)	639 x 2
Sound Pressure Level	Cooling	dB(A)	66.5	66.8	67.8	68.0
	Heating	dB(A)	68.2	68.9	69.3	70.0
Communication Cable		mm² x No. (VCTF-SB)	1.0 - 1.5 x 2C	1.0 - 1.5 x 2C	1.0 - 1.5 x 2C	1.0 - 1.5 x 2C
Refrigerant	Refrigerant name		R410A	R410A	R410A	R410A
	Precharged Amount in factory	kg	16.0 + 13.0	16.0 + 14.0	16.0 + 14.0	16.0 + 16.0
		lbs	35.3 + 28.7	35.3 + 30.9	35.3 + 30.9	35.3 + 35.3
	t-CO ₂ eq			60.5	62.6	62.6
Control			Electronic Expansion Valve	Electronic Expansion Valve	Electronic Expansion Valve	Electronic Expansion Valve
Power Supply		Ø, V, Hz	3, 380-415, 50	3, 380-415, 50	3, 380-415, 50	3, 380-415, 50
Number of maximum connectable indoor units			64	64	64	64

- Note
- Due to our policy of innovation some specifications may be changed without notification.
 - Wiring cable size must comply with the applicable local and national codes. And "Electric characteristics" chapter should be considered for electrical work and design. Especially the power cable and circuit breaker should be selected in accordance with that.
 - Power factor could vary less than ±1% according to the operating conditions.
 - Sound pressure level is measured on the rated condition in the anechoic rooms by ISO 3745 standard. Sound power level is measured on the rated condition in the reverberation rooms by ISO 3741 standard. Therefore, these values can be increased owing to ambient conditions during operation.
 - Performances are based on the following conditions :
*Cooling : Indoor Ambient Temp. 27°CDB / 19°CWB, Outdoor Ambient Temp. 35°CDB / 24°CWB
*Heating : Indoor Ambient Temp. 20°CDB / 15°CWB, Outdoor Ambient Temp. 7°CDB / 6°CWB
Interconnected Pipe Length is 7.5m and difference of Elevation (Outdoor - Indoor Unit) is Zero.
 - The numbers in parentheses means maximum connectable indoor units in accordance with outdoor units combination. The recommended ratio is 130%.
 - This product contains Fluorinated greenhouse gases. (R410A, GWP(Global warming potential) = 2087.5)

MULTI V 5

ARUN500LTE5 / ARUN520LTE5
ARUN540LTE5 / ARUN560LTE5



HP			50	52	54	56
Model Name	Combination Unit		ARUN500LTE5	ARUN520LTE5	ARUN540LTE5	ARUN560LTE5
	Independent Unit		ARUN240LTE5 ARUN140LTE5 ARUN120LTE5	ARUN240LTE5 ARUN160LTE5 ARUN120LTE5	ARUN240LTE5 ARUN180LTE5 ARUN120LTE5	ARUN240LTE5 ARUN200LTE5 ARUN120LTE5
Capacity	Cooling (Rated)	kW	140.0	145.6	151.2	156.8
		Btu/h	477,700	496,800	515,900	535,000
	Heating (Rated)	kW	156.2	162.5	168.8	175.1
		Btu/h	532,900	554,400	575,900	597,400
Input	Cooling (Rated)	kW	33.78	35.46	36.97	38.97
	Heating (Rated)	kW	36.68	38.49	38.97	42.42
EER (Rated)			4.14	4.11	4.24	4.24
COP (Rated)			4.26	4.22	4.33	4.13
Power Factor	Rated	-	0.93	0.93	0.93	0.93
Exterior	Color		Warm Gray / Dawn Gray	Warm Gray / Dawn Gray	Warm Gray / Dawn Gray	Warm Gray / Dawn Gray
	RAL code		NL503K / NA507K	NL503K / NA507K	NL503K / NA507K	NL503K / NA507K
Heat Exchanger			Wide Louver Plus	Wide Louver Plus	Wide Louver Plus	Wide Louver Plus
Compressor	Motor Output x Number	W x No.	5,300 x 4	5,300 x 4	(5,300 x 4) + (4,200 x 1)	5,300 x 5
	Type		Propeller fan	Propeller fan	Propeller fan	Propeller fan
Fan	Motor Output x Number	W	(900 x 4) + (1,200 x 1)	(900 x 4) + (1,200 x 1)	(900 x 4) + (1,200 x 1)	(900 x 4) + (1,200 x 1)
	Air Flow Rate (High)	m³/min	(320 x 2) + (240 x 1)	(320 x 2) + (240 x 1)	(320 x 2) + (240 x 1)	(320 x 2) + (240 x 1)
		ft³/min	(11,301 x 2) + (8,476 x 1)	(11,301 x 2) + (8,476 x 1)	(11,301 x 2) + (8,476 x 1)	(11,301 x 2) + (8,476 x 1)
	External Static Pressure (Max, Pa)			80	80	80
	Drive			DC INVERTER	DC INVERTER	DC INVERTER
	Discharge		Side / Top	TOP	TOP	TOP
Pipe Connections	Liquid Pipe	mm (inch)	19.05 (3/4)	19.05 (3/4)	19.05 (3/4)	19.05 (3/4)
	Gas Pipe	mm (inch)	41.3 (1-5/8)	41.3 (1-5/8)	41.3 (1-5/8)	41.3 (1-5/8)
Dimensions (W x H x D)		mm x No.	(1,240 x 1,690 x 760) x 2 + (930 x 1,690 x 760) x 1	(1,240 x 1,690 x 760) x 2 + (930 x 1,690 x 760) x 1	(1,240 x 1,690 x 760) x 2 + (930 x 1,690 x 760) x 1	(1,240 x 1,690 x 760) x 2 + (930 x 1,690 x 760) x 1
Net Weight		kg	(276 x 1) + (220 x 1) + (188 x 1)	(276 x 1) + (220 x 1) + (188 x 1)	(276 x 1) + (260 x 1) + (188 x 1)	(276 x 1) + (274 x 1) + (188 x 1)
Sound Pressure Level	Cooling	dB(A)	67.0	67.1	67.2	67.4
	Heating	dB(A)	68.6	68.7	68.8	69.5
Communication Cable		mm² x No. (VCTF-SB)	1.0 - 1.5 x 2C	1.0 - 1.5 x 2C	1.0 - 1.5 x 2C	1.0 - 1.5 x 2C
Refrigerant	Refrigerant name		R410A	R410A	R410A	R410A
	Precharged Amount in factory	kg	16.0 + 13.0 + 10.0	16.0 + 13.0 + 10.0	16.0 + 13.0 + 10.0	16.0 + 14.0 + 10.0
		lbs	35.3 + 28.7 + 22.0	35.3 + 28.7 + 22.0	35.3 + 28.7 + 22.0	35.3 + 30.9 + 22.0
	t-CO ₂ eq			81.4	81.4	83.5
Control			Electronic Expansion Valve	Electronic Expansion Valve	Electronic Expansion Valve	Electronic Expansion Valve
Power Supply		Ø, V, Hz	3, 380-415, 50	3, 380-415, 50	3, 380-415, 50	3, 380-415, 50
Number of maximum connectable indoor units			64	64	64	64

- Note
- Due to our policy of innovation some specifications may be changed without notification.
 - Wiring cable size must comply with the applicable local and national codes. And "Electric characteristics" chapter should be considered for electrical work and design. Especially the power cable and circuit breaker should be selected in accordance with that.
 - Power factor could vary less than ±1% according to the operating conditions.
 - Sound pressure level is measured on the rated condition in the anechoic rooms by ISO 3745 standard. Sound power level is measured on the rated condition in the reverberation rooms by ISO 3741 standard. Therefore, these values can be increased owing to ambient conditions during operation.
 - Performances are based on the following conditions :
*Cooling : Indoor Ambient Temp. 27°CDB / 19°CWB, Outdoor Ambient Temp. 35°CDB / 24°CWB
*Heating : Indoor Ambient Temp. 20°CDB / 15°CWB, Outdoor Ambient Temp. 7°CDB / 6°CWB
Interconnected Pipe Length is 7.5m and difference of Elevation (Outdoor - Indoor Unit) is Zero.
 - The numbers in parentheses means maximum connectable indoor units in accordance with outdoor units combination. The recommended ratio is 130%.
 - This product contains Fluorinated greenhouse gases. (R410A, GWP(Global warming potential) = 2087.5)

MULTI V 5

ARUN580LTE5 / ARUN600LTE5
ARUN620LTE5 / ARUN640LTE5



HP		58	60	62	64	
Model Name	Combination Unit	ARUN580LTE5	ARUN600LTE5	ARUN620LTE5	ARUN640LTE5	
	Independent Unit	ARUN240LTE5 ARUN220LTE5 ARUN120LTE5	ARUN240LTE5 ARUN240LTE5 ARUN120LTE5	ARUN240LTE5 ARUN240LTE5 ARUN140LTE5	ARUN240LTE5 ARUN240LTE5 ARUN160LTE5	
Capacity	Cooling (Rated)	kW	162.4	168.0	173.6	179.2
		Btu/h	554,100	573,200	592,400	611,500
	Heating (Rated)	kW	181.4	186.3	192.6	198.9
		Btu/h	618,900	635,800	657,300	678,800
Input	Cooling (Rated)	kW	39.51	41.42	42.63	44.31
	Heating (Rated)	kW	44.45	45.75	47.47	49.28
EER (Rated)		4.11	4.06	4.07	4.04	
COP (Rated)		4.08	4.07	4.06	4.04	
Power Factor	Rated	-	0.93	0.93	0.93	
Exterior	Color	Warm Gray / Dawn Gray	Warm Gray / Dawn Gray	Warm Gray / Dawn Gray	Warm Gray / Dawn Gray	
	RAL code	NL503K / NA507K	NL503K / NA507K	NL503K / NA507K	NL503K / NA507K	
Heat Exchanger		Wide Louver Plus	Wide Louver Plus	Wide Louver Plus	Wide Louver Plus	
Compressor	Motor Output x Number	W x No.	5,300 x 5	5,300 x 5	5,300 x 5	5,300 x 5
	Type		Propeller fan	Propeller fan	Propeller fan	Propeller fan
Fan	Motor Output x Number	W	(900 x 4) + (1,200 x 1)	(900 x 4) + (1,200 x 1)	900 x 6	900 x 6
	Air Flow Rate (High)	m ³ /min	(320 x 2) + (240 x 1)	(320 x 2) + (240 x 1)	320 x 3	320 x 3
		ft ³ /min	(11,301 x 2) + (8,476 x 1)	(11,301 x 2) + (8,476 x 1)	11,301 x 3	11,301 x 3
	External Static Pressure (Max, Pa)		80	80	80	80
	Drive		DC INVERTER	DC INVERTER	DC INVERTER	DC INVERTER
Pipe Connections	Liquid Pipe	mm (inch)	19.05 (3/4)	19.05 (3/4)	22.2 (7/8)	22.2 (7/8)
	Gas Pipe	mm (inch)	41.3 (1-5/8)	41.3 (1-5/8)	44.5 (1-3/4)	44.5 (1-3/4)
Dimensions (W x H x D)	mm x No.	(1,240 x 1,690 x 760) x 2 + (930 x 1,690 x 760) x 1	(1,240 x 1,690 x 760) x 2 + (930 x 1,690 x 760) x 1	(1,240 x 1,690 x 760) x 3	(1,240 x 1,690 x 760) x 3	
Net Weight		kg	(276 x 1) + (274 x 1) + (188 x 1)	(276 x 2) + (188 x 1)	(276 x 2) + (220 x 1)	(276 x 2) + (220 x 1)
		lbs	(608 x 1) + (604 x 1) + (414 x 1)	(608 x 2) + (414 x 1)	(608 x 2) + (485 x 1)	(608 x 2) + (485 x 1)
Sound Pressure Level	Cooling	dB(A)	68.3	68.5	68.6	68.7
	Heating	dB(A)	69.8	70.4	70.5	70.6
Communication Cable	mm ² x No. (VCTF-SB)		1.0 - 1.5 x 2C	1.0 - 1.5 x 2C	1.0 - 1.5 x 2C	1.0 - 1.5 x 2C
Refrigerant	Refrigerant name		R410A	R410A	R410A	R410A
	Precharged Amount in factory	kg	16.0 + 14.0 + 10.0	16.0 + 16.0 + 10.0	16.0 + 16.0 + 13.0	16.0 + 16.0 + 13.0
		lbs	35.3 + 30.9 + 22.0	35.3 + 35.3 + 22.0	35.3 + 35.3 + 28.7	35.3 + 35.3 + 28.7
	t-CO ₂ eq		83.5	87.7	93.9	93.9
	Control		Electronic Expansion Valve	Electronic Expansion Valve	Electronic Expansion Valve	Electronic Expansion Valve
Power Supply	Ø, V, Hz		3, 380-415, 50	3, 380-415, 50	3, 380-415, 50	3, 380-415, 50
			3, 380, 60	3, 380, 60	3, 380, 60	3, 380, 60
Number of maximum connectable indoor units			64	64	64	64

- Note
- Due to our policy of innovation some specifications may be changed without notification.
 - Wiring cable size must comply with the applicable local and national codes. And "Electric characteristics" chapter should be considered for electrical work and design. Especially the power cable and circuit breaker should be selected in accordance with that.
 - Power factor could vary less than ±1% according to the operating conditions.
 - Sound pressure level is measured on the rated condition in the anechoic rooms by ISO 3745 standard. Sound power level is measured on the rated condition in the reverberation rooms by ISO 3741 standard. Therefore, these values can be increased owing to ambient conditions during operation.
 - Performances are based on the following conditions:
 - *Cooling : Indoor Ambient Temp. 27°CDB / 19°CWB, Outdoor Ambient Temp. 35°CDB / 24°CWB
 - *Heating : Indoor Ambient Temp. 20°CDB / 15°CWB, Outdoor Ambient Temp. 7°CDB / 6°CWB
 Interconnected Pipe Length is 7.5m and difference of Elevation (Outdoor - Indoor Unit) is Zero.
 - The numbers in parentheses means maximum connectable indoor units in accordance with outdoor units combination. The recommended ratio is 130%.
 - This product contains Fluorinated greenhouse gases. (R410A, GWP(Global warming potential) = 2087.5)

MULTI V 5

ARUN660LTE5 / ARUN680LTE5
ARUN700LTE5 / ARUN720LTE5



HP		66	68	70	72	
Model Name	Combination Unit	ARUN660LTE5	ARUN680LTE5	ARUN700LTE5	ARUN720LTE5	
	Independent Unit	ARUN240LTE5 ARUN240LTE5 ARUN180LTE5	ARUN240LTE5 ARUN240LTE5 ARUN200LTE5	ARUN240LTE5 ARUN240LTE5 ARUN220LTE5	ARUN240LTE5 ARUN240LTE5 ARUN240LTE5	
Capacity	Cooling (Rated)	kW	184.8	190.4	196.0	201.6
		Btu/h	630,600	649,700	668,800	687,900
	Heating (Rated)	kW	205.2	211.5	217.8	222.8
		Btu/h	700,300	721,800	743,300	760,200
Input	Cooling (Rated)	kW	44.47	45.82	48.36	50.27
	Heating (Rated)	kW	49.76	53.21	55.24	56.54
EER (Rated)		4.16	4.16	4.05	4.01	
COP (Rated)		4.12	3.97	3.94	3.94	
Power Factor	Rated	-	0.93	0.93	0.93	
Exterior	Color	Warm Gray / Dawn Gray	Warm Gray / Dawn Gray	Warm Gray / Dawn Gray	Warm Gray / Dawn Gray	
	RAL code	NL503K / NA507K	NL503K / NA507K	NL503K / NA507K	NL503K / NA507K	
Heat Exchanger		Wide Louver Plus	Wide Louver Plus	Wide Louver Plus	Wide Louver Plus	
Compressor	Motor Output x Number	W x No.	(5,300 x 5) + (4,200 x 1)	5,300 x 6	5,300 x 6	5,300 x 6
	Type		Propeller fan	Propeller fan	Propeller fan	Propeller fan
Fan	Motor Output x Number	W	900 x 6	900 x 6	900 x 6	900 x 6
	Air Flow Rate (High)	m ³ /min	320 x 3	320 x 3	320 x 3	320 x 3
		ft ³ /min	11,301 x 3	11,301 x 3	11,301 x 3	11,301 x 3
	External Static Pressure (Max, Pa)		80	80	80	80
	Drive		DC INVERTER	DC INVERTER	DC INVERTER	DC INVERTER
Pipe Connections	Liquid Pipe	mm (inch)	22.2 (7/8)	22.2 (7/8)	22.2 (7/8)	22.2 (7/8)
	Gas Pipe	mm (inch)	53.98 (2-1/8)	53.98 (2-1/8)	53.98 (2-1/8)	53.98 (2-1/8)
Dimensions (W x H x D)	mm x No.	(1,240 x 1,690 x 760) x 3	(1,240 x 1,690 x 760) x 3	(1,240 x 1,690 x 760) x 3	(1,240 x 1,690 x 760) x 3	
Net Weight		kg	(276 x 2) + (260 x 1)	(276 x 2) + (274 x 1)	(276 x 2) + (274 x 1)	276 x 3
		lbs	(608 x 2) + (573 x 1)	(608 x 2) + (604 x 1)	(608 x 2) + (604 x 1)	608 x 3
Sound Pressure Level	Cooling	dB(A)	68.8	69.0	69.6	69.8
	Heating	dB(A)	70.6	71.1	71.3	71.8
Communication Cable	mm ² x No. (VCTF-SB)		1.0 - 1.5 x 2C	1.0 - 1.5 x 2C	1.0 - 1.5 x 2C	1.0 - 1.5 x 2C
Refrigerant	Refrigerant name		R410A	R410A	R410A	R410A
	Precharged Amount in factory	kg	16.0 + 16.0 + 13.0	16.0 + 16.0 + 14.0	16.0 + 16.0 + 14.0	16.0 + 16.0 + 16.0
		lbs	35.3 + 35.3 + 28.7	35.3 + 35.3 + 30.9	35.3 + 35.3 + 30.9	35.3 + 35.3 + 35.3
	t-CO ₂ eq		93.9	96.0	96.0	100.2
	Control		Electronic Expansion Valve	Electronic Expansion Valve	Electronic Expansion Valve	Electronic Expansion Valve
Power Supply	Ø, V, Hz		3, 380-415, 50	3, 380-415, 50	3, 380-415, 50	3, 380-415, 50
			3, 380, 60	3, 380, 60	3, 380, 60	3, 380, 60
Number of maximum connectable indoor units			64	64	64	64

- Note
- Due to our policy of innovation some specifications may be changed without notification.
 - Wiring cable size must comply with the applicable local and national codes. And "Electric characteristics" chapter should be considered for electrical work and design. Especially the power cable and circuit breaker should be selected in accordance with that.
 - Power factor could vary less than ±1% according to the operating conditions.
 - Sound pressure level is measured on the rated condition in the anechoic rooms by ISO 3745 standard. Sound power level is measured on the rated condition in the reverberation rooms by ISO 3741 standard. Therefore, these values can be increased owing to ambient conditions during operation.
 - Performances are based on the following conditions:
 - *Cooling : Indoor Ambient Temp. 27°CDB / 19°CWB, Outdoor Ambient Temp. 35°CDB / 24°CWB
 - *Heating : Indoor Ambient Temp. 20°CDB / 15°CWB, Outdoor Ambient Temp. 7°CDB / 6°CWB
 Interconnected Pipe Length is 7.5m and difference of Elevation (Outdoor - Indoor Unit) is Zero.
 - The numbers in parentheses means maximum connectable indoor units in accordance with outdoor units combination. The recommended ratio is 130%.
 - This product contains Fluorinated greenhouse gases. (R410A, GWP(Global warming potential) = 2087.5)

MULTI V 5

ARUN740LTE5 / ARUN760LTE5
ARUN780LTE5 / ARUN800LTE5



HP			74	76	78	80
Model Name	Combination Unit		ARUN740LTE5	ARUN760LTE5	ARUN780LTE5	ARUN800LTE5
	Independent Unit		ARUN240LTE5 ARUN240LTE5 ARUN140LTE5 ARUN120LTE5	ARUN240LTE5 ARUN240LTE5 ARUN160LTE5 ARUN120LTE5	ARUN240LTE5 ARUN240LTE5 ARUN180LTE5 ARUN120LTE5	ARUN240LTE5 ARUN240LTE5 ARUN200LTE5 ARUN120LTE5
Capacity	Cooling (Rated)	kW	207.2	212.8	218.4	224.0
		Btu/h	707,000	726,100	745,200	764,300
	Heating (Rated)	kW	230.4	236.7	243.0	249.3
		Btu/h	786,300	807,800	829,300	850,800
Input	Cooling (Rated)	kW	50.54	52.22	52.38	53.73
	Heating (Rated)	kW	55.53	57.34	57.82	61.27
EER (Rated)			4.10	4.08	4.17	4.17
COP (Rated)			4.15	4.13	4.20	4.07
Power Factor	Rated	-	0.93	0.93	0.93	0.93
Exterior	Color		Warm Gray / Dawn Gray	Warm Gray / Dawn Gray	Warm Gray / Dawn Gray	Warm Gray / Dawn Gray
	RAL code		NL503K / NA507K	NL503K / NA507K	NL503K / NA507K	NL503K / NA507K
Heat Exchanger			Wide Louver Plus	Wide Louver Plus	Wide Louver Plus	Wide Louver Plus
Compressor	Motor Output x Number	W x No.	5,300 x 6	5,300 x 6	(5,300 x 6) + (4,200 x 1)	5,300 x 7
	Type		Propeller fan	Propeller fan	Propeller fan	Propeller fan
Fan	Motor Output x Number	W	(900 x 6) + (1,200 x 1)	(900 x 6) + (1,200 x 1)	(900 x 6) + (1,200 x 1)	(900 x 6) + (1,200 x 1)
	Air Flow Rate (High)	m ³ /min	(320 x 3) + (240 x 1)	(320 x 3) + (240 x 1)	(320 x 3) + (240 x 1)	(320 x 3) + (240 x 1)
		ft ³ /min	(11,301 x 3) + (8,476 x 1)	(11,301 x 3) + (8,476 x 1)	(11,301 x 3) + (8,476 x 1)	(11,301 x 3) + (8,476 x 1)
	External Static Pressure (Max, Pa)		80	80	80	80
	Drive		DC INVERTER	DC INVERTER	DC INVERTER	DC INVERTER
Pipe Connections	Liquid Pipe	mm (inch)	22.2 (7/8)	22.2 (7/8)	22.2 (7/8)	22.2 (7/8)
	Gas Pipe	mm (inch)	53.98 (2-1/8)	53.98 (2-1/8)	53.98 (2-1/8)	53.98 (2-1/8)
Dimensions (W x H x D)		mm x No.	(1,240 x 1,690 x 760) x 3 + (930 x 1,690 x 760) x 1	(1,240 x 1,690 x 760) x 3 + (930 x 1,690 x 760) x 1	(1,240 x 1,690 x 760) x 3 + (930 x 1,690 x 760) x 1	(1,240 x 1,690 x 760) x 3 + (930 x 1,690 x 760) x 1
Net Weight		kg	(276 x 2) + (220 x 1) + (188 x 1)	(276 x 2) + (220 x 1) + (188 x 1)	(276 x 2) + (260 x 1) + (188 x 1)	(276 x 2) + (274 x 1) + (188 x 1)
		lbs	(608 x 2) + (485 x 1) + (414 x 1)	(608 x 2) + (485 x 1) + (414 x 1)	(608 x 2) + (573 x 1) + (414 x 1)	(608 x 2) + (604 x 1) + (414 x 1)
Sound Pressure Level	Cooling	dB(A)	69.1	69.2	69.2	69.4
	Heating	dB(A)	70.9	70.9	71.0	71.4
Communication Cable		mm ² x No. (VCTF-SB)	1.0 - 1.5 x 2C	1.0 - 1.5 x 2C	1.0 - 1.5 x 2C	1.0 - 1.5 x 2C
Refrigerant	Refrigerant name		R410A	R410A	R410A	R410A
	Precharged Amount in factory	kg	16.0 + 16.0 + 13.0 + 10.0	16.0 + 16.0 + 13.0 + 10.0	16.0 + 16.0 + 13.0 + 10.0	16.0 + 16.0 + 14.0 + 10.0
		lbs	35.3 + 35.3 + 28.7 + 22.0	35.3 + 35.3 + 28.7 + 22.0	35.3 + 35.3 + 28.7 + 22.0	35.3 + 35.3 + 30.9 + 22.0
	t-CO ₂ ,eq		114.8	114.8	114.8	116.9
Control			Electronic Expansion Valve	Electronic Expansion Valve	Electronic Expansion Valve	Electronic Expansion Valve
Power Supply		Ø, V, Hz	3, 380-415, 50	3, 380-415, 50	3, 380-415, 50	3, 380-415, 50
			3, 380, 60	3, 380, 60	3, 380, 60	3, 380, 60
Number of maximum connectable indoor units			64	64	64	64

- Note
- Due to our policy of innovation some specifications may be changed without notification.
 - Wiring cable size must comply with the applicable local and national codes. And "Electric characteristics" chapter should be considered for electrical work and design. Especially the power cable and circuit breaker should be selected in accordance with that.
 - Power factor could vary less than ±1% according to the operating conditions.
 - Sound pressure level is measured on the rated condition in the anechoic rooms by ISO 3745 standard. Sound power level is measured on the rated condition in the reverberation rooms by ISO 3741 standard. Therefore, these values can be increased owing to ambient conditions during operation.
 - Performances are based on the following conditions :
*Cooling : Indoor Ambient Temp. 27°CDB / 19°CWB, Outdoor Ambient Temp. 35°CDB / 24°CWB
*Heating : Indoor Ambient Temp. 20°CDB / 15°CWB, Outdoor Ambient Temp. 7°CDB / 6°CWB
Interconnected Pipe Length is 7.5m and difference of Elevation (Outdoor - Indoor Unit) is Zero.
 - The numbers in parentheses means maximum connectable indoor units in accordance with outdoor units combination. The recommended ratio is 130%.
 - This product contains Fluorinated greenhouse gases. (R410A, GWP(Global warming potential) = 2087.5)

MULTI V 5

ARUN820LTE5 / ARUN840LTE5
ARUN860LTE5 / ARUN880LTE5



HP			82	84	86	88
Model Name	Combination Unit		ARUN820LTE5	ARUN840LTE5	ARUN860LTE5	ARUN880LTE5
	Independent Unit		ARUN240LTE5 ARUN240LTE5 ARUN220LTE5 ARUN120LTE5	ARUN240LTE5 ARUN240LTE5 ARUN240LTE5 ARUN120LTE5	ARUN240LTE5 ARUN240LTE5 ARUN240LTE5 ARUN140LTE5	ARUN240LTE5 ARUN240LTE5 ARUN240LTE5 ARUN160LTE5
Capacity	Cooling (Rated)	kW	229.6	235.2	240.8	246.4
		Btu/h	783,400	802,500	821,700	840,800
	Heating (Rated)	kW	255.6	260.6	266.9	273.2
		Btu/h	872,300	889,200	910,700	932,200
Input	Cooling (Rated)	kW	56.27	58.18	59.39	61.07
	Heating (Rated)	kW	63.30	64.60	66.32	68.13
EER (Rated)			4.08	4.04	4.05	4.03
COP (Rated)			4.04	4.03	4.02	4.01
Power Factor	Rated	-	0.93	0.93	0.93	0.93
Exterior	Color		Warm Gray / Dawn Gray	Warm Gray / Dawn Gray	Warm Gray / Dawn Gray	Warm Gray / Dawn Gray
	RAL code		NL503K / NA507K	NL503K / NA507K	NL503K / NA507K	NL503K / NA507K
Heat Exchanger			Wide Louver Plus	Wide Louver Plus	Wide Louver Plus	Wide Louver Plus
Compressor	Motor Output x Number	W x No.	5,300 x 7	5,300 x 7	5,300 x 7	5,300 x 7
	Type		Propeller fan	Propeller fan	Propeller fan	Propeller fan
Fan	Motor Output x Number	W	(900 x 6) + (1,200 x 1)	(900 x 6) + (1,200 x 1)	900 x 8	900 x 8
	Air Flow Rate (High)	m ³ /min	(320 x 3) + (240 x 1)	(320 x 3) + (240 x 1)	320 x 4	320 x 4
		ft ³ /min	(11,301 x 3) + (8,476 x 1)	(11,301 x 3) + (8,476 x 1)	11,301 x 4	11,301 x 4
	External Static Pressure (Max, Pa)		80	80	80	80
	Drive		DC INVERTER	DC INVERTER	DC INVERTER	DC INVERTER
Pipe Connections	Liquid Pipe	mm (inch)	22.2 (7/8)	22.2 (7/8)	22.2 (7/8)	22.2 (7/8)
	Gas Pipe	mm (inch)	53.98 (2-1/8)	53.98 (2-1/8)	53.98 (2-1/8)	53.98 (2-1/8)
Dimensions (W x H x D)		mm x No.	(1,240 x 1,690 x 760) x 3 + (930 x 1,690 x 760) x 1	(1,240 x 1,690 x 760) x 3 + (930 x 1,690 x 760) x 1	(1,240 x 1,690 x 760) x 4	(1,240 x 1,690 x 760) x 4
Net Weight		kg	(276 x 2) + (274 x 1) + (188 x 1)	(276 x 3) + (188 x 1)	(276 x 3) + (188 x 1)	(276 x 3) + (220 x 1)
		lbs	(608 x 2) + (604 x 1) + (414 x 1)	(608 x 3) + (414 x 1)	(608 x 3) + (485 x 1)	(608 x 3) + (485 x 1)
Sound Pressure Level	Cooling	dB(A)	70.0	70.1	70.2	70.3
	Heating	dB(A)	71.6	72.1	72.1	72.2
Communication Cable		mm ² x No. (VCTF-SB)	1.0 - 1.5 x 2C	1.0 - 1.5 x 2C	1.0 - 1.5 x 2C	1.0 - 1.5 x 2C
Refrigerant	Refrigerant name		R410A	R410A	R410A	R410A
	Precharged Amount in factory	kg	16.0 + 16.0 + 14.0 + 10.0	16.0 + 16.0 + 16.0 + 10.0	16.0 + 16.0 + 16.0 + 13.0	16.0 + 16.0 + 16.0 + 13.0
		lbs	35.3 + 35.3 + 30.9 + 22.0	35.3 + 35.3 + 35.3 + 22.0	35.3 + 35.3 + 35.3 + 28.7	35.3 + 35.3 + 35.3 + 28.7
	t-CO ₂ ,eq		116.9	121.1	127.3	127.3
Control			Electronic Expansion Valve	Electronic Expansion Valve	Electronic Expansion Valve	Electronic Expansion Valve
Power Supply		Ø, V, Hz	3, 380-415, 50	3, 380-415, 50	3, 380-415, 50	3, 380-415, 50
			3, 380, 60	3, 380, 60	3, 380, 60	3, 380, 60
Number of maximum connectable indoor units			64	64	64	64

- Note
- Due to our policy of innovation some specifications may be changed without notification.
 - Wiring cable size must comply with the applicable local and national codes. And "Electric characteristics" chapter should be considered for electrical work and design. Especially the power cable and circuit breaker should be selected in accordance with that.
 - Power factor could vary less than ±1% according to the operating conditions.
 - Sound pressure level is measured on the rated condition in the anechoic rooms by ISO 3745 standard. Sound power level is measured on the rated condition in the reverberation rooms by ISO 3741 standard. Therefore, these values can be increased owing to ambient conditions during operation.
 - Performances are based on the following conditions :
*Cooling : Indoor Ambient Temp. 27°CDB / 19°CWB, Outdoor Ambient Temp. 35°CDB / 24°CWB
*Heating : Indoor Ambient Temp. 20°CDB / 15°CWB, Outdoor Ambient Temp. 7°CDB / 6°CWB
Interconnected Pipe Length is 7.5m and difference of Elevation (Outdoor - Indoor Unit) is Zero.
 - The numbers in parentheses means maximum connectable indoor units in accordance with outdoor units combination. The recommended ratio is 130%.
 - This product contains Fluorinated greenhouse gases. (R410A, GWP(Global warming potential) = 2087.5)

MULTI V 5

ARUN900LTE5 / ARUN920LTE5
ARUN940LTE5 / ARUN960LTE5



HP		90	92	94	96	
Model Name	Combination Unit	ARUN900LTE5	ARUN920LTE5	ARUN940LTE5	ARUN960LTE5	
	Independent Unit	ARUN240LTE5 ARUN240LTE5 ARUN240LTE5 ARUN180LTE5	ARUN240LTE5 ARUN240LTE5 ARUN240LTE5 ARUN200LTE5	ARUN240LTE5 ARUN240LTE5 ARUN240LTE5 ARUN220LTE5	ARUN240LTE5 ARUN240LTE5 ARUN240LTE5 ARUN240LTE5	
Capacity	Cooling (Rated)	kW	252.0	257.6	263.2	268.8
		Btu/h	859,900	879,000	898,100	917,200
	Heating (Rated)	kW	279.5	285.8	292.1	297.0
		Btu/h	953,700	975,200	996,700	1,013,600
Input	Cooling (Rated)	kW	61.23	62.58	65.12	67.03
	Heating (Rated)	kW	68.60	72.06	74.08	75.39
EER (Rated)			4.12	4.12	4.04	4.01
COP (Rated)			4.07	3.97	3.94	3.94
Power Factor		Rated	0.93	0.93	0.93	0.93
Exterior	Color	Warm Gray / Dawn Gray	Warm Gray / Dawn Gray	Warm Gray / Dawn Gray	Warm Gray / Dawn Gray	
	RAL code	NL503K / NA507K	NL503K / NA507K	NL503K / NA507K	NL503K / NA507K	
Heat Exchanger		Wide Louver Plus	Wide Louver Plus	Wide Louver Plus	Wide Louver Plus	
Compressor	Motor Output x Number	W x No.	(5,300 x 7) + (4,200 x 1)	5,300 x 8	5,300 x 8	5,300 x 8
	Type		Propeller fan	Propeller fan	Propeller fan	Propeller fan
Fan	Motor Output x Number	W	900 x 8	900 x 8	900 x 8	900 x 8
	Air Flow Rate (High)	m ³ /min	320 x 4	320 x 4	320 x 4	320 x 4
		ft ³ /min	11,301 x 4	11,301 x 4	11,301 x 4	11,301 x 4
	External Static Pressure (Max, Pa)			80	80	80
	Drive			DC INVERTER	DC INVERTER	DC INVERTER
Discharge		Side / Top	TOP	TOP	TOP	
Pipe Connections	Liquid Pipe	mm (inch)	22.2 (7/8)	22.2 (7/8)	22.2 (7/8)	22.2 (7/8)
	Gas Pipe	mm (inch)	53.98 (2-1/8)	53.98 (2-1/8)	53.98 (2-1/8)	53.98 (2-1/8)
Dimensions (W x H x D)		mm x No.	(1,240 x 1,690 x 760) x 4	(1,240 x 1,690 x 760) x 4	(1,240 x 1,690 x 760) x 4	(1,240 x 1,690 x 760) x 4
Net Weight		kg	(276 x 3) + (260 x 1)	(276 x 3) + (274 x 1)	(276 x 3) + (274 x 1)	(276 x 4)
		lbs	(608 x 3) + (573 x 1)	(608 x 3) + (604 x 1)	(608 x 3) + (604 x 1)	608 x 4
Sound Pressure Level	Cooling	dB(A)	70.3	70.4	70.9	71.0
	Heating	dB(A)	72.2	72.5	72.7	73.0
Communication Cable		mm ² x No. (VCTF-SB)	1.0 - 1.5 x 2C	1.0 - 1.5 x 2C	1.0 - 1.5 x 2C	1.0 - 1.5 x 2C
Refrigerant	Refrigerant name		R410A	R410A	R410A	R410A
	Precharged Amount in factory	kg	16.0 + 16.0 + 16.0 + 13.0	16.0 + 16.0 + 16.0 + 14.0	16.0 + 16.0 + 16.0 + 14.0	16.0 + 16.0 + 16.0 + 16.0
		lbs	35.3 + 35.3 + 35.3 + 28.7	35.3 + 35.3 + 35.3 + 30.9	35.3 + 35.3 + 35.3 + 30.9	35.3 + 35.3 + 35.3 + 35.3
	t-CO ₂ eq			127.3	129.4	133.6
	Control			Electronic Expansion Valve	Electronic Expansion Valve	Electronic Expansion Valve
Power Supply	Ø, V, Hz		3, 380-415, 50	3, 380-415, 50	3, 380-415, 50	3, 380-415, 50
			3, 380, 60	3, 380, 60	3, 380, 60	3, 380, 60
Number of maximum connectable indoor units			64	64	64	64

- Note
- Due to our policy of innovation some specifications may be changed without notification.
 - Wiring cable size must comply with the applicable local and national codes. And "Electric characteristics" chapter should be considered for electrical work and design. Especially the power cable and circuit breaker should be selected in accordance with that.
 - Power factor could vary less than ±1% according to the operating conditions.
 - Sound pressure level is measured on the rated condition in the anechoic rooms by ISO 3745 standard. Sound power level is measured on the rated condition in the reverberation rooms by ISO 3741 standard. Therefore, these values can be increased owing to ambient conditions during operation.
 - Performances are based on the following conditions:
 - *Cooling : Indoor Ambient Temp. 27°CDB / 19°CWB, Outdoor Ambient Temp. 35°CDB / 24°CWB
 - *Heating : Indoor Ambient Temp. 20°CDB / 15°CWB, Outdoor Ambient Temp. 7°CDB / 6°CWB
 Interconnected Pipe Length is 7.5m and difference of Elevation (Outdoor - Indoor Unit) is Zero.
 - The numbers in parentheses means maximum connectable indoor units in accordance with outdoor units combination. The recommended ratio is 130%.
 - This product contains Fluorinated greenhouse gases. (R410A, GWP(Global warming potential) = 2087.5)

NOTE

Field Wiring

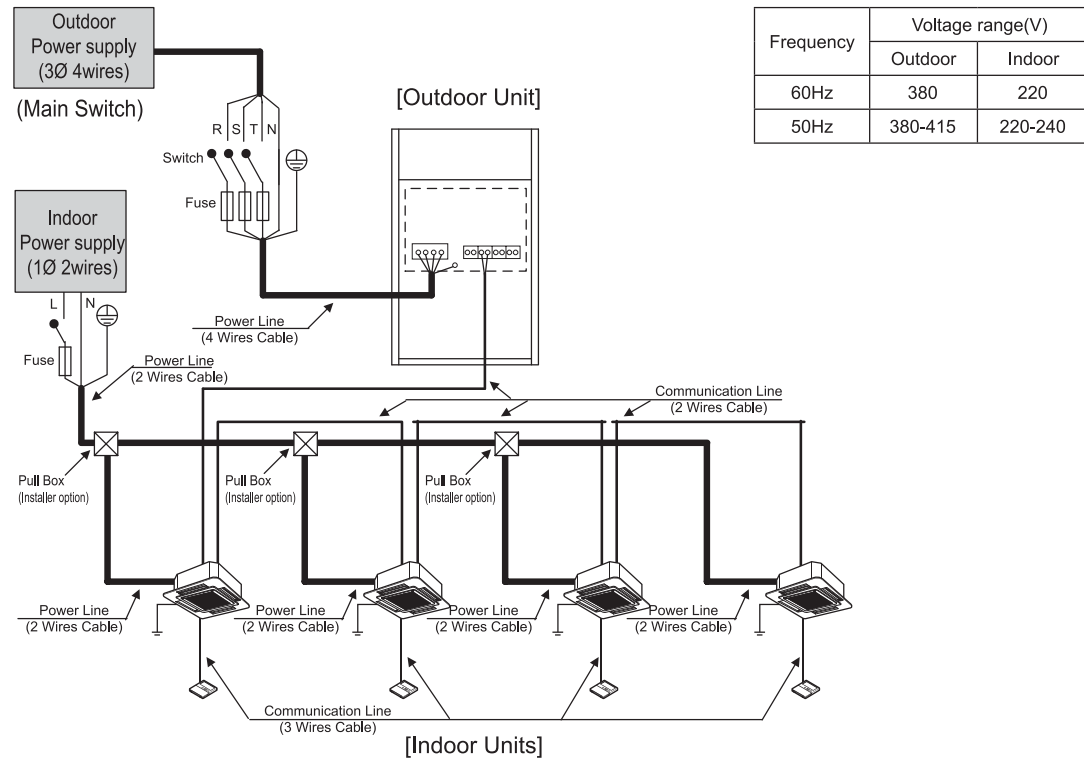

WARNING

Indoor Unit ground Lines are required for preventing electrical shock accident during current leakage, Communication disorder by noise effect and motor current leakage (without connection to pipe).

- Don't install an individual switch or electrical outlet to disconnect each of indoor unit separately from the power supply.
- If individual power supply is necessary for each indoor unit, IPM (Independent Power Module) should be applied at each indoor unit. (optional)
- Install the main switch that can interrupt all the power sources in an integrated manner because this system consists of the equipment utilizing the multiple power sources.
- If there exists the possibility of reversed phase, lose phase, momentary blackout or the power goes on and off while the product is operating, attach a reversed phase protection circuit locally.

Running the product in reversed phase may break the compressor and other parts.

Between Indoor and Master Outdoor unit

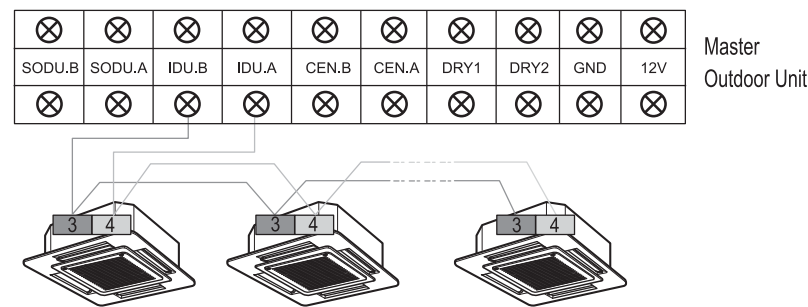

The GND terminal at the main PCB is a 'L' terminal for day contact, it is not the point to make ground connection.

Field Wiring

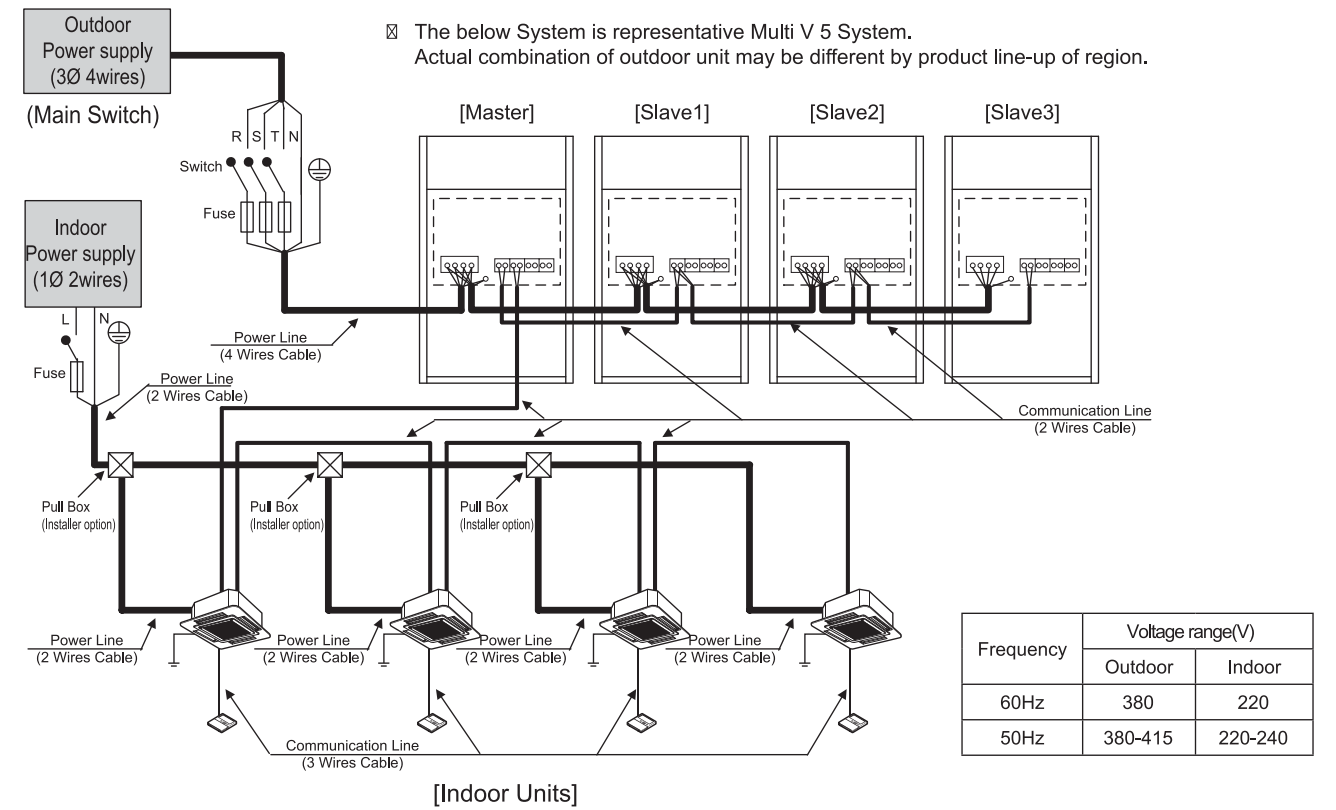

WARNING

When the total capacity is over than 68Hp, do not use single power source for connecting series units. The First terminal block could be burnt out.

◆ When the power source is supplied to Each outdoor unit individually.

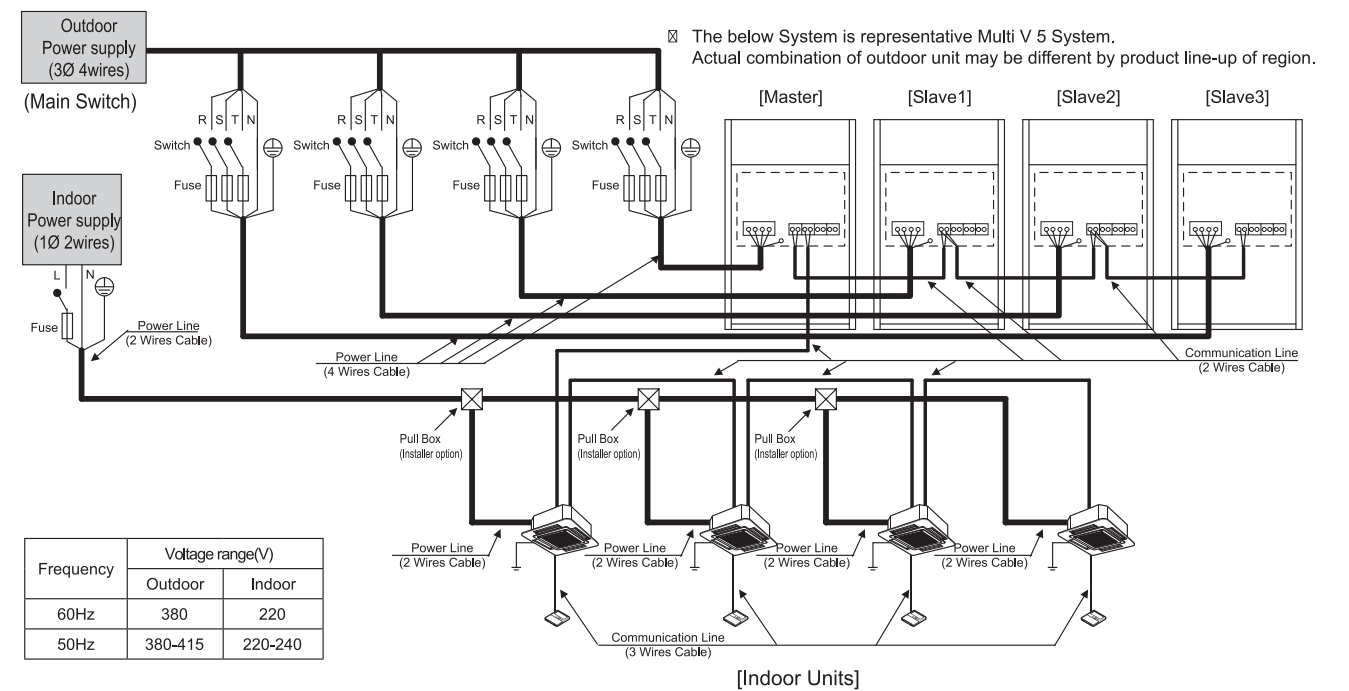

Field Wiring

⚠ WARNING

- Indoor Unit ground Lines are required for preventing electrical shock accident during current leakage, Communication disorder by noise effect and motor current leakage (without connection to pipe).
 - Don't install an individual switch or electrical outlet to disconnect each of indoor unit separately from the power supply.
 - If individual power supply is necessary for each indoor unit, IPM (Independent Power Module) should be applied at each indoor unit. (optional)
 - Install the main switch that can interrupt all the power sources in an integrated manner because this system consists of the equipment utilizing the multiple power sources.
 - If there exists the possibility of reversed phase, lose phase, momentary blackout or the power goes on and off while the product is operating, attach a reversed phase protection circuit locally.
- Running the product in reversed phase may break the compressor and other parts.

◆ Between Indoor and Master Outdoor unit

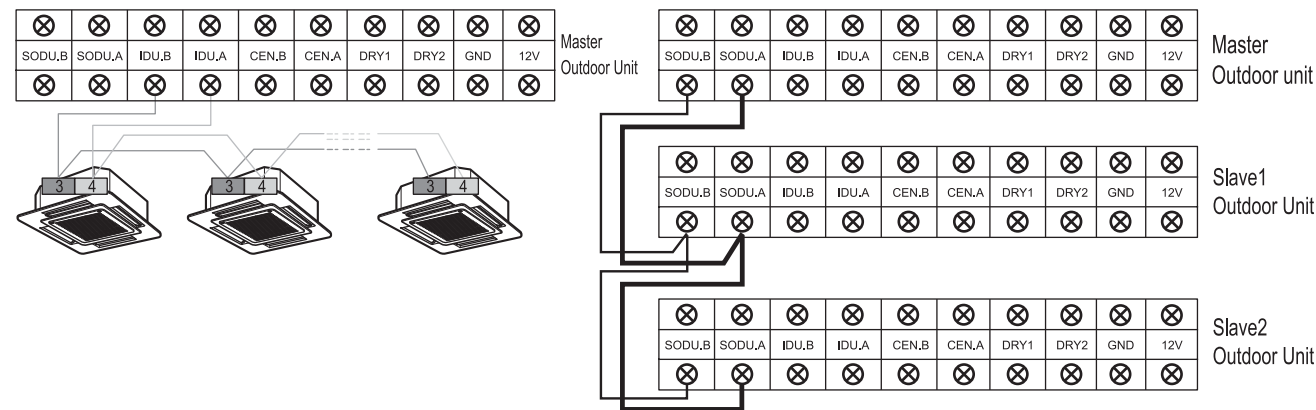

The GND terminal at the main PCB is a '-' terminal for dry contact. It is not the point to make ground connection.

- Make sure that terminal number of master and slave outdoor units are

■ Example Connection of Communication Cable

- Connection of communication cable must be installed like below figure between indoor unit to outdoor unit.

- Abnormal operation can be caused by communication defect, when connection of communication cable is installed like below figure.

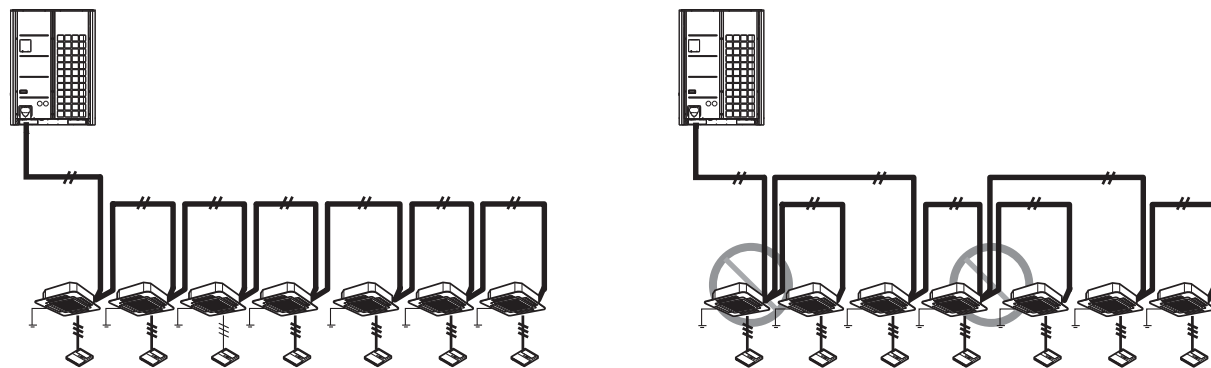

Electric Characteristics

■ Wiring of Main Power Supply and Equipment Capacity

1. Use a separate power supply for the Outdoor Unit and Indoor Unit.
2. Bear in mind ambient conditions (ambient temperature, direct sunlight, rain liquid, etc.) when proceeding with the wiring and connections
3. The wire size is the minimum value for metal conduit wiring. The power cord size should be 1 rank thicker taking into account the line voltage drops. Make sure the power-supply voltage does not drop more than 10%.
4. Specific wiring requirements should adhere to the wiring regulations of the region.
5. Power supply cords of parts of appliances for outdoor use should not be lighter than polychloroprene sheathed flexible cord (design 60245 IEC57).
6. Don't install an individual switch or electrical outlet to disconnect each of indoor unit separately from the power supply.

⚠ WARNING

- Follow ordinance of local regulation for technical standard related to electrical equipment, wiring regulations and guidance of each electric power company.
- Make sure to use specified wires for connections so that no external force is imparted to terminal connections. If connections are not fixed firmly, it may cause heating or fire.
- Make sure to use the appropriate type of overcurrent protection switch. Note that generated overcurrent may include some amount of direct current.
- All installation site may require attachment of an earth leakage breaker. If no earth leakage breaker is installed, it may cause an electric shock.

⚠ CAUTION

- Do not use anything other than breaker and fuse with correct capacity. Using fuse and wire or copper wire with too large capacity may cause a malfunction of unit or fire.

Electric Characteristics

[Unit : mm]

Model	Unit			Power Supply			COMP			OFM	
	Hz	Volts	Voltage-range	MCA	TOCA	MFA	MSC	RLA(Cooling)	RLA(Heating)	kW	FLA
8 HP	50	380-415	Min.:342, Max.:456	25.2	28.0	32	5.9	5.0	5.5	1.20	2.5
10 HP	50	380-415	Min.:342, Max.:456	25.5	28.0	32	5.9	6.8	7.2	1.20	2.5
12 HP	50	380-415	Min.:342, Max.:456	25.5	28.0	32	5.9	10.4	11.9	1.20	2.5
14 HP	50	380-415	Min.:342, Max.:456	26.1	29.0	32	5.9	12.4	13.4	1.80	2.5
16 HP	50	380-415	Min.:342, Max.:456	27.3	30.0	32	5.9	15.1	18.8	1.80	2.5
18 HP	50	380-415	Min.:342, Max.:456	40.0	44.0	50	10.2	12.5	16.5	1.80	2.5
20 HP	50	380-415	Min.:342, Max.:456	41.8	46.0	50	11.8	17.6	21.5	1.80	2.5
22 HP	50	380-415	Min.:342, Max.:456	46.8	52.0	50	11.8	21.7	24.9	1.80	2.5
24 HP	50	380-415	Min.:342, Max.:456	50.0	56.0	63	11.8	24.9	28.2	1.80	2.5
26 HP	50	380-415	Min.:342, Max.:456	54.5	60.0	63	11.8	29.2	28.1	1.80	2.5
22' HP	50	380-415	Min.:342, Max.:456	50.9	56.0	63	11.8	17.2	19.1	2.40	5.0
24' HP	50	380-415	Min.:342, Max.:456	50.9	56.0	63	11.8	20.8	23.8	2.40	5.0
26' HP	50	380-415	Min.:342, Max.:456	51.8	57.0	63	11.8	22.8	25.4	3.00	5.0
28 HP	50	380-415	Min.:342, Max.:456	52.7	58.0	63	11.8	25.6	30.7	3.00	5.0
30 HP	50	380-415	Min.:342, Max.:456	65.5	72.0	80	16.1	26.1	28.5	3.00	5.0
32 HP	50	380-415	Min.:342, Max.:456	67.3	74.0	80	17.7	28.0	33.4	3.00	5.0
34 HP	50	380-415	Min.:342, Max.:456	72.7	80.0	80	17.7	32.2	36.8	3.00	5.0
36 HP	50	380-415	Min.:342, Max.:456	76.4	84.0	80	17.7	35.3	40.1	3.00	5.0
38 HP	50	380-415	Min.:342, Max.:456	77.3	85.0	100	17.7	37.3	41.6	3.60	5.0
40 HP	50	380-415	Min.:342, Max.:456	78.2	86.0	100	17.7	40.0	47.0	3.60	5.0
42 HP	50	380-415	Min.:342, Max.:456	90.9	100.0	100	22.0	40.6	44.8	3.60	5.0
44 HP	50	380-415	Min.:342, Max.:456	92.7	102.0	100	23.6	42.5	49.7	3.60	5.0
46 HP	50	380-415	Min.:342, Max.:456	96.4	108.0	100	23.6	46.6	53.1	3.60	5.0
48 HP	50	380-415	Min.:342, Max.:456	101.8	112.0	125	23.6	49.8	56.4	3.60	5.0
50 HP	50	380-415	Min.:342, Max.:456	102.3	113.0	125	23.6	47.7	53.6	4.80	7.5
52 HP	50	380-415	Min.:342, Max.:456	103.6	114.0	125	23.6	50.4	58.9	4.80	7.5
54 HP	50	380-415	Min.:342, Max.:456	116.4	128.0	125	27.9	51.0	56.7	4.80	7.5
56 HP	50	380-415	Min.:342, Max.:456	117.1	130.0	125	29.5	52.9	61.6	4.80	7.5
58 HP	50	380-415	Min.:342, Max.:456	123.6	136.0	150	29.5	57.0	65.0	4.80	7.5
60 HP	50	380-415	Min.:342, Max.:456	126.7	140.0	150	29.5	60.2	68.3	4.80	7.5
62 HP	50	380-415	Min.:342, Max.:456	127.0	141.0	150	29.5	62.2	69.9	5.40	7.5
64 HP	50	380-415	Min.:342, Max.:456	129.1	142.0	150	29.5	64.9	75.2	5.40	7.5
66 HP	50	380-415	Min.:342, Max.:456	140.5	156.0	150	33.8	65.5	73.0	5.40	7.5
68 HP	50	380-415	Min.:342, Max.:456	143.6	158.0	150	35.4	67.4	77.9	5.40	7.5
70 HP	50	380-415	Min.:342, Max.:456	149.1	164.0	150	35.4	71.5	81.3	5.40	7.5
72 HP	50	380-415	Min.:342, Max.:456	151.4	168.0	175	35.4	74.6	84.6	5.40	7.5
74 HP	50	380-415	Min.:342, Max.:456	152.9	169.0	175	35.4	72.6	81.8	6.60	10.0
76 HP	50	380-415	Min.:342, Max.:456	154.5	170.0	175	35.4	75.3	87.1	6.60	10.0
78 HP	50	380-415	Min.:342, Max.:456	167.3	184.0	200	39.7	75.9	84.9	6.60	10.0
80 HP	50	380-415	Min.:342, Max.:456	169.1	186.0	200	41.3	77.8	89.8	6.60	10.0
82 HP	50	380-415	Min.:342, Max.:456	174.5	192.0	200	41.3	81.9	93.2	6.60	10.0
84 HP	50	380-415	Min.:342, Max.:456	176.6	196.0	200	41.3	85.1	96.6	6.60	10.0
86 HP	50	380-415	Min.:342, Max.:456	177.5	197.0	200	41.3	87.0	98.1	7.20	10.0

1. Voltage supplied to the unit terminals should be within the minimum and maximum range.
2. Maximum allowable voltage unbalance between phase is 2%.
3. MSC means the Max. current during the starting of compressor.
4. MSC and RLA are measured as the compressor only test condition.
5. OFM are measured as the outdoor unit test condition.
6. TOCA means the total over current value of each outdoor unit.
7. Select the wire size based on the larger value among MCA or TOCA.
8. MFA is used to select the circuit breaker and ground fault circuit interrupter, and all installation site must require attachment of an earth leakage breaker. [circuit breaker type is ELCB(Earth Leakage Circuit Breaker)].
9. Select the electrical equipment of combination unit according to the electrical characteristics of individual unit.
: 2 unit combination models

Symbols

- MCA** : Minimum Circuit Amperes (A)
- TOCA** : Total Over Current Amperes (A)
- MFA** : Maximum Fuse Amperes (A)
- MSC** : Maximum Starting Current (A)
- RLA** : Rated Load Amperes (A)
- OFM** : Outdoor Fan Motor
- kW** : Fan Motor rated output (kW)
- FLA** : Full Load Amperes (A)

Electric Characteristics

[Unit : mm]

Model	Unit			Power Supply			COMP			OFM	
	Hz	Volts	Voltage-range	MCA	TOCA	MFA	MSC	RLA(Cooling)	RLA(Heating)	kW	FLA
88 HP	50	380-415	Min.:342, Max.:456	180.0	198.0	200	41.3	89.8	103.4	7.20	10.0
90 HP	50	380-415	Min.:342, Max.:456	192.7	212.0	200	45.6	90.4	101.2	7.20	10.0
92 HP	50	380-415	Min.:342, Max.:456	194.5	214.0	200	47.2	92.2	106.1	7.20	10.0
94 HP	50	380-415	Min.:342, Max.:456	200.0	220.0	200	47.2	96.4	109.5	7.20	10.0
96 HP	50	380-415	Min.:342, Max.:456	203.6	224.0	250	47.2	99.5	112.8	7.20	10.0

1. Voltage supplied to the unit terminals should be within the minimum and maximum range.
2. Maximum allowable voltage unbalance between phase is 2%.
3. MSC means the Max. current during the starting of compressor.
4. MSC and RLA are measured as the compressor only test condition.
5. OFM are measured as the outdoor unit test condition.
6. TOCA means the total over current value of each outdoor unit.
7. Select the wire size based on the larger value among MCA or TOCA.
8. MFA is used to select the circuit breaker and ground fault circuit interrupter, and all installation site must require attachment of an earth leakage breaker. [circuit breaker type is ELCB(Earth Leakage Circuit Breaker)].
9. Select the electrical equipment of combination unit according to the electrical characteristics of individual unit.
: 2 unit combination models

Symbols

- MCA** : Minimum Circuit Amperes (A)
- TOCA** : Total Over Current Amperes (A)
- MFA** : Maximum Fuse Amperes (A)
- MSC** : Maximum Starting Current (A)
- RLA** : Rated Load Amperes (A)
- OFM** : Outdoor Fan Motor
- kW** : Fan Motor rated output (kW)
- FLA** : Full Load Amperes (A)

Dimensions

[Unit : mm]

ARUN08OLTE5 / ARUN10OLTE5 / ARUN12OLTE5

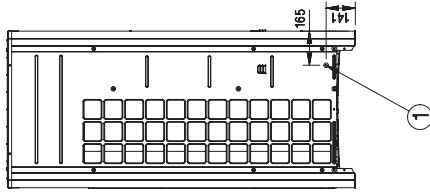
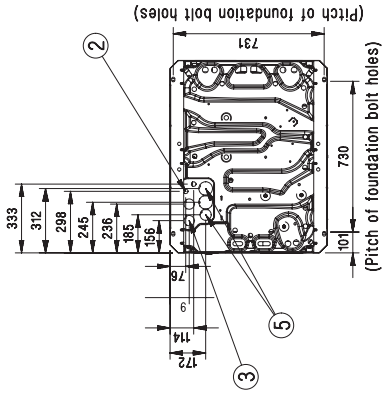
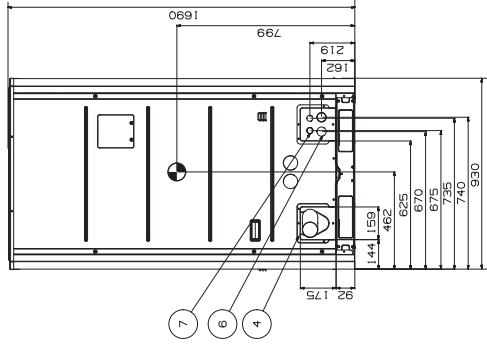
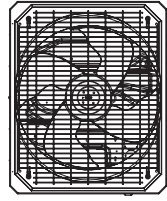
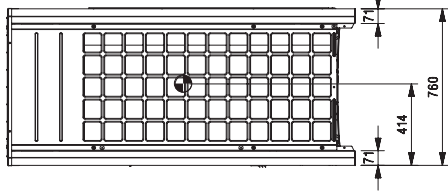
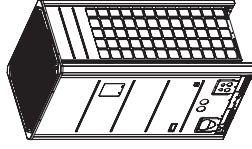

System	Heat Recovery		Heat Pump	
	Liquid pipe	High Pressure Gas pipe	Liquid pipe	Gas pipe
HP				
8	Ø 9.52 (3/8)	Ø 15.88 (5/8)	Ø 9.52 (3/8)	Ø 19.05 (3/4)
10	Ø 9.52 (3/8)	Ø 22.2 (7/8)	Ø 9.52 (3/8)	Ø 22.2 (7/8)
12	Ø 12.7 (1/2)	Ø 28.58 (1-1/8)	Ø 12.7 (1/2)	Ø 28.58 (1-1/8)

No.	Part Name	Description
7	Wire routing hole(front)	2- Ø 30
6	Power cord routing hole(front)	2- Ø 45
5	Pipe routing hole(bottom)	2- Ø 66, Ø 53.88
4	Pipe routing hole(front)	-
3	Power cord routing hole(bottom)	2- Ø 50
2	Wire routing hole(bottom)	2- Ø 22.2
1	Leakage test hole(side)	Ø 22.2

Note
 1. Unit should be installed in compliance with the installation manual in the product box.
 2. Unit should be grounded in accordance with the local regulations or applicable national codes.
 3. All electrical components and materials to be supplied from the site must comply with the local regulations or international codes.
 4. Electrical characteristics chapter should be considered for electrical work and design. Especially the power cable and circuit breaker should be selected in accordance with that.

[Unit: mm]

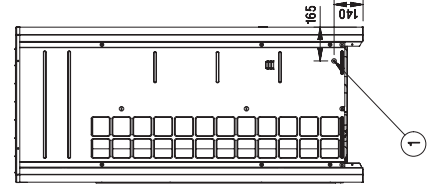
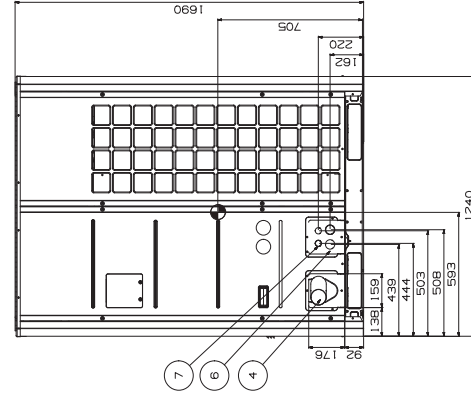
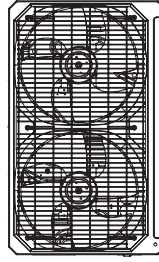
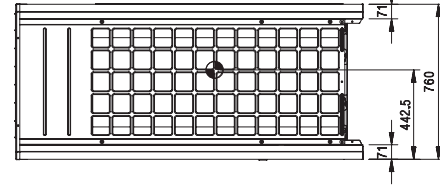
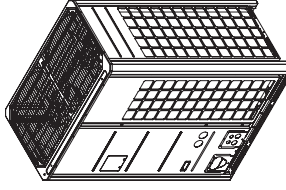

System	Heat Recovery		Heat Pump	
	Liquid pipe	High Pressure Gas pipe	Liquid pipe	Gas pipe
HP				
14-16	Ø 12.7 (1/2)	Ø 28.58 (1-1/8)	Ø 12.7 (1/2)	Ø 28.58 (1-1/8)
18-20	Ø 15.88 (5/8)	Ø 28.58 (1-1/8)	Ø 15.88 (5/8)	Ø 28.58 (1-1/8)
22	Ø 15.88 (5/8)	Ø 28.58 (1-1/8)	Ø 15.88 (5/8)	Ø 28.58 (1-1/8)
24	Ø 15.88 (5/8)	Ø 34.9 (1-3/8)	Ø 15.88 (5/8)	Ø 34.9 (1-3/8)
26-34	Ø 19.05 (3/4)	Ø 34.9 (1-3/8)	Ø 19.05 (3/4)	Ø 34.9 (1-3/8)
36-40	Ø 19.05 (3/4)	Ø 41.3 (1-5/8)	Ø 19.05 (3/4)	Ø 41.3 (1-5/8)
42-60	Ø 19.05 (3/4)	Ø 41.3 (1-5/8)	Ø 19.05 (3/4)	Ø 41.3 (1-5/8)
62-64	Ø 22.2 (7/8)	Ø 44.5 (1-3/4)	Ø 22.2 (7/8)	Ø 44.5 (1-3/4)
66-96	Ø 22.2 (7/8)	Ø 53.98 (2-1/8)	Ø 22.2 (7/8)	Ø 53.98 (2-1/8)

No.	Part Name	Description
7	Wire routing hole(front)	2- Ø 30
6	Power cord routing hole(front)	2- Ø 45
5	Pipe routing hole(bottom)	2- Ø 66, Ø 53.88
4	Pipe routing hole(front)	-
3	Power cord routing hole(bottom)	2- Ø 50
2	Wire routing hole(bottom)	Ø 22.2
1	Leakage test hole(side)	Ø 22.2

Note
 1. Unit should be installed in compliance with the installation manual in the product box.
 2. Unit should be grounded in accordance with the local regulations or applicable national codes.
 3. All electrical components and materials to be supplied from the site must comply with the local regulations or international codes.
 4. Electrical characteristics chapter should be considered for electrical work and design. Especially the power cable and circuit breaker should be selected in accordance with that.

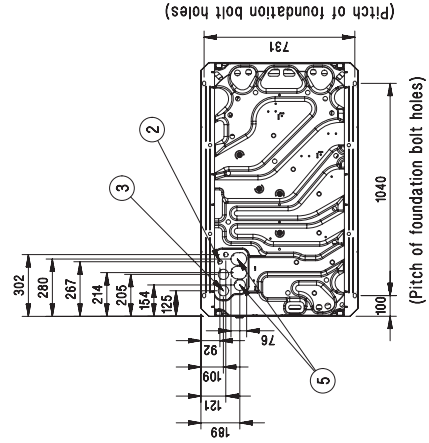

[Unit: mm]

